

AIR CONDITIONER

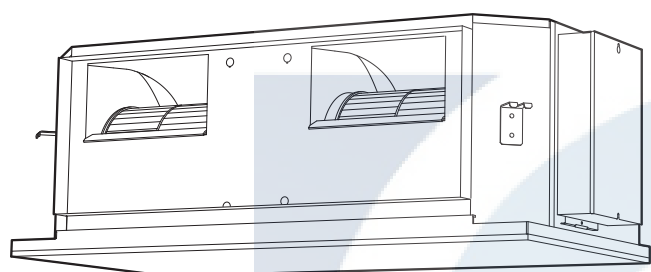

INSTALLATION MANUAL

For authorized service personnel only.

English

INSTALLATIONSANLEITUNG

Nur für autorisiertes Personal.

Deutsch

MANUEL D'INSTALLATION

Pour le personnel agréé uniquement.

Français

MANUAL DE INSTALACIÓN

Solo para personal autorizado.

Español

MANUALE D'INSTALLAZIONE

Ad uso esclusivo del personale autorizzato.

Italiano

ΕΓΧΕΙΡΙΔΙΟ ΕΓΚΑΤΑΣΤΑΣΗΣ

Για εξουσιοδοτημένο προσωπικό σέρβις.

Ελληνικά

MANUAL DE INSTALAÇÃO

Apenas para técnicos autorizados.

Português

РУКОВОДСТВО ПО УСТАНОВКЕ

Для уполномоченного персонала.

Русский

KURULUM KILAVUZU

Yetkili servis personeli içindir.

Türkçe

PART NO. 9379123037-02

INSTALLATION MANUAL

PART NO. 9379123037-02
INDOOR UNIT (Duct Type)

Contents

1. SAFETY PRECAUTIONS.....	2
2. ABOUT THE UNIT.....	2
2.1. Precautions for using the R410A refrigerant.....	2
2.2. Special tool for R410A.....	2
2.3. Accessories.....	3
2.4. Optional parts.....	3
3. INSTALLATION WORK.....	3
3.1. Selecting an installation location.....	3
3.2. Installation dimension.....	3
3.3. Installation the unit.....	4
4. PIPE INSTALLATION.....	5
4.1. Selecting the pipe material.....	5
4.2. Pipe requirement.....	5
4.3. Flare connection (Pipe connection).....	5
4.4. Installing heat insulation.....	6
5. INSTALLING DRAIN PIPES.....	6
5.1. Installing drain pipes (Ceiling concealed type).....	6
6. ELECTRICAL WIRING.....	7
6.1. Wiring system diagram.....	8
6.2. Connection cable preparation.....	8
6.3. Connection of wiring.....	8
7. REMOTE CONTROLLER SETTING.....	9
7.1. Installing the remote controller.....	9
7.2. Setting the dip switches.....	9
8. FUNCTION SETTING.....	10
8.1. Turning on the power.....	10
8.2. Function setting.....	10
8.3. Group control system.....	12
8.4. Dual remote controllers.....	12
9. TEST RUN.....	13
10. CHECK LIST.....	13
11. OPTIONAL KIT INSTALLATION (OPTION).....	13
12. CUSTOMER GUIDANCE.....	13
13. ERROR CODES.....	14

1. SAFETY PRECAUTIONS

- Be sure to read this Manual thoroughly before installation.
- The warnings and precautions indicated in this Manual contain important information pertaining to your safety. Be sure to observe them.
- Hand this Manual, together with the Operating Manual to the customer. Request the customer to keep them on hand for future use, such as for relocating or repairing the unit.

 WARNING!	This mark indicates procedures which, if improperly performed, might lead to the death or serious injury of the user.
<ul style="list-style-type: none"> • Request your dealer or a professional installer to install the unit in accordance with this Manual. An improperly installed unit can cause serious accidents such as water leakage, electric shock, or fire. If the unit is installed in disregard of the instructions in the Installation Manual, it will void the manufacturer's warranty. 	
<ul style="list-style-type: none"> • Do not turn ON the power until all work has been completed. Turning ON the power before the work is completed can cause serious accidents such as electric shock or fire. 	
<ul style="list-style-type: none"> • If refrigerant leaks while work is being carried out, ventilate the area. If the refrigerant comes in contact with a flame, it produces a toxic gas. 	
<ul style="list-style-type: none"> • Installation work must be performed in accordance with national wiring standards by authorized personnel only. 	
<ul style="list-style-type: none"> • Except for EMERGENCY, never turn off main as well as sub breaker of the indoor units during operation. It will cause compressor failure as well as water leakage. First, stop the indoor unit by operating the control unit, converter or external input device and then cut the breaker. Make sure to operate through the control unit, converter or external input device. When the breaker is designed, locate it at a place where the users cannot start and stop in the daily work. 	

CAUTION!

This mark indicates procedures which, if improperly performed, might possibly result in personal harm to the user, or damage to property.

Read carefully all security information before use or install the air conditioner.

Do not attempt to install the air conditioner or a part of the air conditioner by yourself.

This unit must be installed by qualified personnel with a capacity certificate for handling refrigerant fluids. Refer to regulation and laws in use on installation place.

The installation must be carried out in compliance with regulations in force in the place of installation and the installation instructions of the manufacturer.

This unit is part of a set constituting an air conditioner. It must not be installed alone or with non-authorized by the manufacturer.

Always use a separate power supply line protected by a circuit breaker operating on all wires with a distance between contact of 3mm for this unit.

The unit must be correctly grounded and the supply line must be equipped with a differential breaker in order to protect the persons.

The units are not explosion proof and therefore should not be installed in explosive atmosphere.

Never touch electrical components immediately after the power supply has been turned off. Electric shock may occur. After turning off the power, always wait 5 minutes before touching electrical components.

This unit contains no user-serviceable parts. Always consult authorized service personnel to repairs.

When moving, consult authorized service personnel for disconnection and installation of the unit.

This appliance is not intended for use by persons (including children) with reduced physical, sensory or mental capabilities, or lack of experience and knowledge, unless they have been given supervision or instruction concerning use of the appliance by a person responsible for their safety. Children should be supervised to ensure that they do not play with the appliance.

2. ABOUT THE UNIT

2.1. Precautions for using the R410A refrigerant

WARNING

- Do not introduce any substance other than the prescribed refrigerant into the refrigeration cycle. If air enters the refrigeration cycle, the pressure in the refrigeration cycle will become abnormally high and cause the piping to rupture.
- If there is a refrigerant leakage, make sure that it does not exceed the concentration limit. If a refrigerant leakage exceeds the concentration limit, it can lead to accidents such as oxygen starvation.
- Do not touch refrigerant that has leaked from the refrigerant pipe connections or other area. Touching the refrigerant directly can cause frostbite.
- If a refrigerant leakage occurs during operation, immediately vacate the premises and thoroughly ventilate the area. If the refrigerant comes in contact with a flame, it produces a toxic gas.

2.2. Special tool for R410A

WARNING

- To install a unit that uses the R410A refrigerant, use dedicated tools and piping materials that have been manufactured specifically for R410A use. Because the pressure of the R410A refrigerant is approximately 1.6 times higher than the R22, failure to use dedicated piping material or improper installation can cause rupture or injury. Furthermore, it can cause serious accidents such as water leakage, electric shock, or fire.











Tool name	Contents of change
Gauge manifold	<ul style="list-style-type: none"> • Pressure is huge and cannot be measured with a conventional gauge. To prevent erroneous mixing of other refrigerants, the diameter of each port has been changed. It is recommended to use a gauge manifold with a high pressure display range -0.1 to 5.3 MPa and a low pressure display range -0.1 to 3.8 MPa.
Charging hose	<ul style="list-style-type: none"> • To increase pressure resistance, the hose material and base size were changed.
Vacuum pump	<ul style="list-style-type: none"> • A conventional vacuum pump can be used by installing a vacuum pump adapter.
Gas leakage detector	<ul style="list-style-type: none"> • Special gas leakage detector for HFC refrigerant R410A.

2.3. Accessories

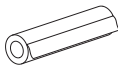
⚠ WARNING

- For installation purposes, be sure to use the parts supplied by the manufacturer or other prescribed parts. The use of non-prescribed parts can cause serious accidents such as the unit to fall, water leakage, electric shock, or fire.
- The following installation parts are furnished. Use them as required.
- Keep the Installation Manual in a safe place and do not discard any other accessories until the installation work has been completed.

Do not discard any accessories needed for installation until the installation work has been completed.

Name and Shape	Q'ty	Application
Operating Manual 	1	
Installation Manual 	1	(This book)
Special nut A (Large flange) 	4	For suspending the indoor unit from ceiling
Special nut B (Small flange) 	4	
Coupler heat insulation (Large) 	1	For indoor side pipe joint (Gas pipe)
Coupler heat insulation (Small) 	1	For indoor side pipe joint (Liquid pipe)
Cable tie (Small) 	1	For fixing the remote controller cable
Remote controller 	1	
Screw (M4 × 16) 	2	For installing indoor unit remote controller
Remote controller cable 	1	For connecting the remote controller

2.4. Optional parts

Parts name	Model No.	Application
Simple remote controller	UTY-RSN*M	For air conditioner operation
Wired remote controller	UTY-RNN*M	For air conditioner operation
Remote sensor unit	UTY-XSZX	Room temperature sensor
External connect kit	UTD-ECS5A	For control input/output port
Long life filter	UTD-LF60KA	

3. INSTALLATION WORK

3.1. Selecting an installation location

Especially, the installation place is very important for the split type air conditioner because it is very difficult to move from place to place after the first installation.

⚠ WARNING

- Select installation locations that can properly support the weight of the indoor. Install the units securely so that they do not topple or fall.

⚠ CAUTION

- Do not install the unit in the following areas:
 - Area with high salt content, such as at the seaside. It will deteriorate metal parts, causing the parts to fail or the unit to leak water.
 - Area filled with mineral oil or containing a large amount of splashed oil or steam, such as a kitchen. It will deteriorate plastic parts, causing the parts to fail or the unit to leak water.
 - Area that generates substances that adversely affect the equipment, such as sulfuric gas, chlorine gas, acid, or alkali. It will cause the copper pipes and brazed joints to corrode, which can cause refrigerant leakage.
 - Area that can cause combustible gas to leak, contains suspended carbon fibers or flammable dust, or volatile inflammables such as paint thinner or gasoline. If gas leaks and settles around the unit, it can cause a fire.
 - Area where animals may urinate on the unit or ammonia may be generated.

- Do not use the unit for special purposes, such as storing food, raising animals, growing plants, or preserving precision devices or art objects. It can degrade the quality of the preserved or stored objects.

- Do not install where there is the danger of combustible gas leakage.

- Do not install the unit near a source of heat, steam, or flammable gas.

- Install the unit where drainage does not cause any trouble.

- Install the indoor unit, outdoor unit, power supply cable, transmission cable, and remote controller cable at least 1 m away from a television or radio receivers. The purpose of this is to prevent TV reception interference or radio noise. (Even if they are installed more than 1 m apart, you could still receive noise under some signal conditions.)

• Decide the mounting position with the customer as follows:

- Install the indoor unit in a location having sufficient strength to support the weight of the indoor unit.
- The inlet and outlet ports should not be obstructed; the air should be able to blow all over the room.
- Leave the space required to service the air conditioner.
- Locate where the air can be distributed evenly throughout the room by the unit.
- Install the unit where connection to the outdoor unit is easy.
- Install the unit where the connection pipe can be easily installed.
- Install the unit where the drain pipe can be easily installed.
- Install the unit where noise and vibration is not amplified.
- Take servicing, etc., into consideration and leave the spaces. Also install the unit where the filter can be removed.
- Providing as much space as possible between the indoor unit and the ceiling will make work much easier.

3.2. Installation dimension

Install at least 20mm from the ceiling.

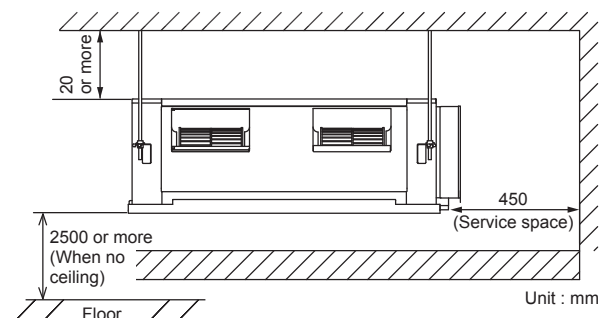

(For maintenance)

- Maintenance work of the control box is possible with the maintenance hole of the measurement shown in the figure.
- If maintenance work is to be done from the bottom side, the maintenance hole needs to be larger than the outside dimension of the indoor unit.
- If maintenance work is to be done from the top, keep the space of the more than 500 mm between the indoor unit and ceiling.

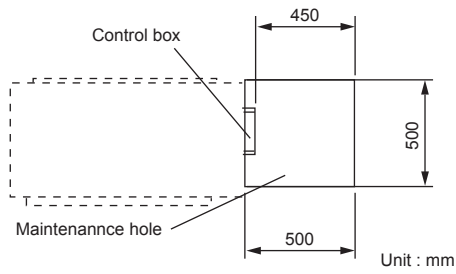

3.3. Installation the unit

⚠ WARNING

- Install the air conditioner in a location which can withstand a load do at least 5 times the weight of the main unit and which will not amplify sound or vibration. If the installation location is not strong enough, the indoor unit may fall and cause injuries.
- If the job is done with the panel frame only, there is a risk that the unit will come loose. Please take care.

⚠ CAUTION

- For installation, refer to the technical data.

RECOMMENDED RANGE OF EXTERNAL STATIC PRESSURE [Pa]

100 - 250

3.3.1. Installing the hangers

Hanging bolt installation diagram

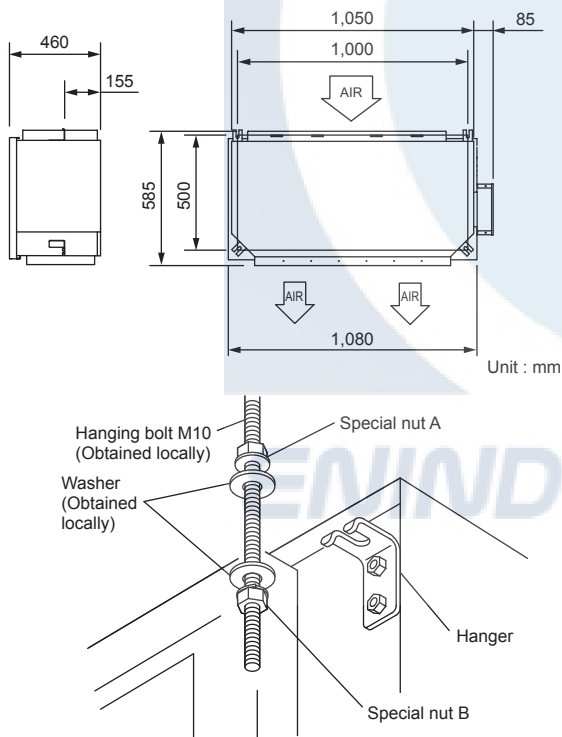

⚠ CAUTION

- Fasten the unit securely with special nuts A and B.

3.3.2. Leveling

Use the procedure in the following figure to adjust the levelness.

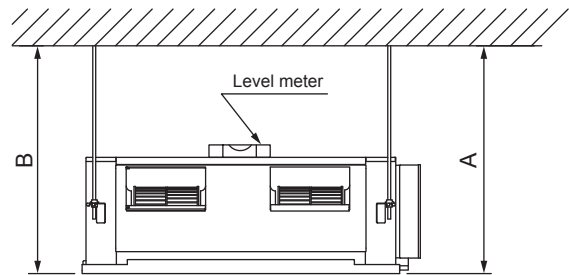

The side A of the unit with the drain port should be slightly lower than the opposite side B of the unit. The height difference between sides A and B should be from 0 to 20mm.

3.3.3. Mounting the duct

Follow the procedure in the following figure to install the ducts.

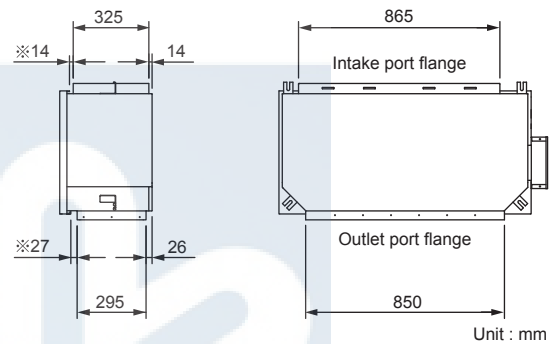

※ Spacing between flange and drain pan.

⚠ CAUTION

- If an intake duct is installed, take care not to damage the temperature sensor (the temperature sensor is attached to the intake port flange).
- Be sure to install the air inlet grille and the air outlet grille for air circulation. The correct temperature cannot be detected. Grills must be installed so that man cannot touch unit fan, and cannot be removed by only hand operation with tool.

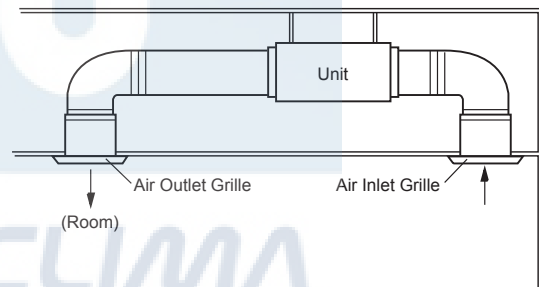

- Be sure to install the air filter in the air inlet. If the air filter is not installed, the heat exchanger may be clogged and its performance may decrease.

4. PIPE INSTALLATION

CAUTION

- Be careful that foreign matter (oil, water, etc.) does not enter the piping with refrigerant R410A models. Also, when storing the piping, securely seal the openings by pinching, taping, etc.
- While brazing the pipes, be sure to purge with dry nitrogen gas.

4.1. Selecting the pipe material

CAUTION

- Do not use existing pipes.
- Use pipes that have clean external and internal sides without any contamination which may cause trouble during use, such as sulfur, oxide, dust, cutting waste, oil, or water.
- It is necessary to use seamless copper pipes.
Material : Phosphor deoxidized seamless copper pipes
It is desirable that the amount of residual oil is less than 40 mg/10 m.
- Do not use copper pipes that have a collapsed, deformed, or discolored portion (especially on the interior surface). Otherwise, the expansion valve or capillary tube may become blocked with contaminants.
- Improper pipe selection will degrade performance. As an air conditioner using R410A incurs pressure higher than when using conventional refrigerant, it is necessary to choose adequate materials.

- Thicknesses of copper pipes used with R410A are as shown in the table.
- Never use copper pipes thinner than those indicated in the table even if they are available on the market.

Thicknesses of Annealed Copper Pipes (R410A)

Pipe outside diameter [mm (in.)]	Thickness [mm]
6.35 (1/4)	0.80
9.52 (3/8)	0.80
12.70 (1/2)	0.80
15.88 (5/8)	1.00
19.05 (3/4)	1.20

4.2. Pipe requirement

CAUTION

- Refer to the Installation Manual of the outdoor unit for description of the length of connecting pipe or for difference of its elevation.

Diameter [mm (in.)]	Liquid	9.52 (3/8)
	Gas	15.88 (5/8)

- Use pipe with water-resistant heat insulation.

CAUTION

- Install heat insulation around both the gas and liquid pipes. Failure to do so may cause water leaks.
Use heat insulation with heat resistance above 120 °C. (Reverse cycle model only)
In addition, if the humidity level at the installation location of the refrigerant piping is expected to exceed 70 %, install heat insulation around the refrigerant piping. If the expected humidity level is 70-80 %, use heat insulation that is 15 mm or thicker and if the expected humidity exceeds 80 %, use heat insulation that is 20 mm or thicker. If heat insulation is used that is not as thick as specified, condensation may form on the surface of the insulation. In addition, use heat insulation with heat conductivity of 0.045 W/(m·K) or less (at 20 °C).

4.3. Flare connection (Pipe connection)

WARNING

- Tighten the flare nuts with a torque wrench using the specified tightening method. Otherwise, the flare nuts could break after a prolonged period, causing refrigerant to leak and generate a hazardous gas if the refrigerant comes into contact with a flame.

4.3.1. Flaring

- Use special pipe cutter and flare tool exclusive for R410A.
- (1) Cut the connection pipe to the necessary length with a pipe cutter.
 - (2) Hold the pipe downward so that cuttings will not enter the pipe and remove any burrs.
 - (3) Insert the flare nut (always use the flare nut attached to the indoor and outdoor units respectively) onto the pipe and perform the flare processing with a flare tool. Use the special R410A flare tool, or the conventional flare tool. Leakage of refrigerant may result if other flare nuts are used.
 - (4) Protect the pipes by pinching them or with tape to prevent dust, dirt, or water from entering the pipes.

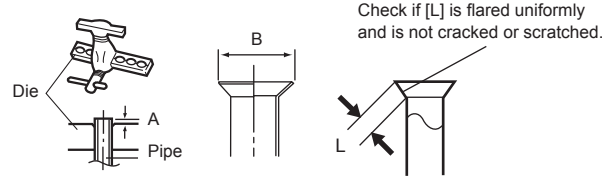

Pipe outside diameter [mm (in.)]	Dimension A [mm]	Dimension B _{0.4} [mm]
	Flare tool for R410A, clutch type	
6.35 (1/4)	0 to 0.5	9.1
9.52 (3/8)		13.2
12.70 (1/2)		16.6
15.88 (5/8)		19.7
19.05 (3/4)		24.0

When using conventional flare tools to flare R410A pipes, the dimension A should be approximately 0.5 mm more than indicated in the table (for flaring with R410A flare tools) to achieve the specified flaring. Use a thickness gauge to measure the dimension A.

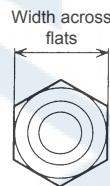

Pipe outside diameter [mm (in.)]	Width across flats of Flare nut [mm]
6.35 (1/4)	17
9.52 (3/8)	22
12.70 (1/2)	26
15.88 (5/8)	29
19.05 (3/4)	36

4.3.2. Bending pipes

- If pipes are shaped by hand, be careful not to collapse them.
- Do not bend the pipes in an angle more than 90°.
- When pipes are repeatedly bend or stretched, the material will harden, making it difficult to bend or stretch them any more.
- Do not bend or stretch the pipes more than 3 times.

CAUTION

- To prevent breaking of the pipe, avoid sharp bends.
- If the pipe is bent repeatedly at the same place, it will break.

4.3.3. Pipe connection

CAUTION

- Be sure to install the pipe against the port on the indoor unit correctly. If the centering is improper, the flare nut cannot tighten smoothly. If the flare nut is forced to turn, the threads will be damaged.
- Do not remove the flare nut from the indoor unit pipe until immediately before connecting the connection pipe.
- Do not use mineral oil on flared part. Prevent mineral oil from getting into the system as this would reduce the lifetime of the units.

- (1) Detach the caps and plugs from the pipes.
- (2) Centering the pipe against port on the indoor unit, turn the flare nut with your hand.

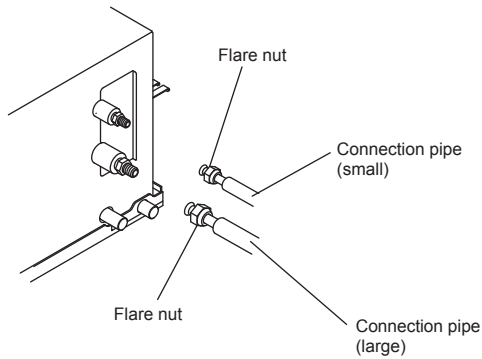

- (3) When the flare nut is tightened properly by your hand, hold the body side coupling with a separate spanner, then tighten with a torque wrench. (See the table below for the flare nut tightening torques.)

CAUTION

- Hold the torque wrench at its grip, keeping it at a right angle with the pipe, in order to tighten the flare nut correctly.
- Tighten the flare nuts with a torque wrench using the specified tightening method. Otherwise, the flare nuts could break after a prolonged period, causing refrigerant to leak and generate a hazardous gas if the refrigerant comes into contact with a flame.
- Connect the piping so that the control box cover can easily be removed for servicing when necessary.
- In order to prevent water from leaking into the control box, make sure that the piping is well insulated.

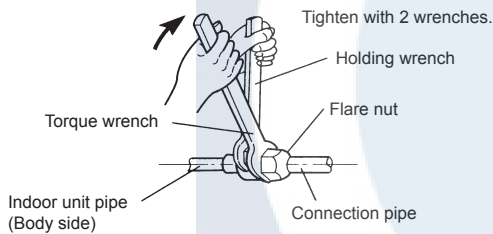

Flare nut [mm (in.)]	Tightening torque [N·m (kgf·cm)]
6.35 (1/4) dia.	16 to 18 (160 to 180)
9.52 (3/8) dia.	32 to 42 (320 to 420)
12.70 (1/2) dia.	49 to 61 (490 to 610)
15.88 (5/8) dia.	63 to 75 (630 to 750)
19.05 (3/4) dia.	90 to 110 (900 to 1,100)

4.4. Installing heat insulation

After checking for gas leaks, insulate by wrapping insulation around the two parts (Gas and Liquid) of the indoor unit coupling, using the coupler heat insulation. After installing the coupler heat insulation, wrap both ends with vinyl tape so that there is no gap. Secure both ends of the heat insulation material using nylon fasteners.

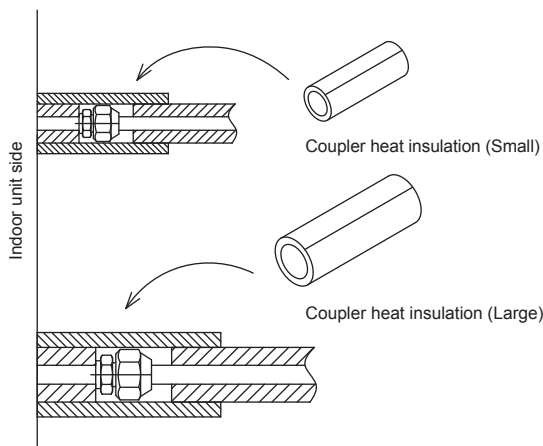

CAUTION

- There should be no gaps between the insulation and the unit.
- After checking for gas leaks (refer to the Installation Manual of the outdoor unit), perform this section.
- Install heat insulation around both the large (gas) and small (liquid) pipes. Failure to do so may cause water leaks.

5. INSTALLING DRAIN PIPES

5.1. Installing drain pipes (Ceiling concealed type)

CAUTION

- Install the drain pipe in accordance with the instructions in this Installation Manual and keep the area warm enough to prevent condensation. Problems with the piping may lead to water leaks.

Install the drain pipes according to the measurements given in the following figure. Flange positions for connecting the drain pipes.

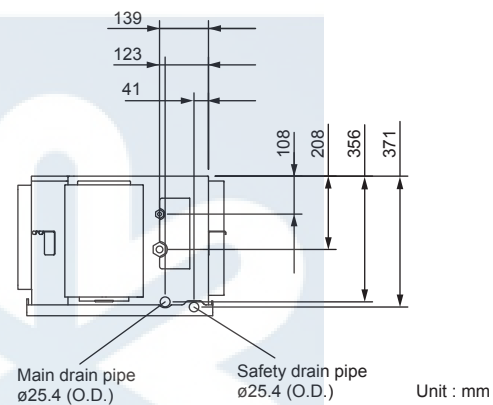

CAUTION

- This UNIT has drain ports in two locations. Follow the procedure in the figure to connect drain pipes to each of them.
- Be sure to properly insulate the drain pipes.

Use general hard polyvinyl chloride pipe (VP25) and connect it with adhesive (polyvinyl chloride) so that there is no leakage.

Do not perform air bleeding.

(1) Main drain pipe

Provide one trap on the main drain pipe near the indoor unit.

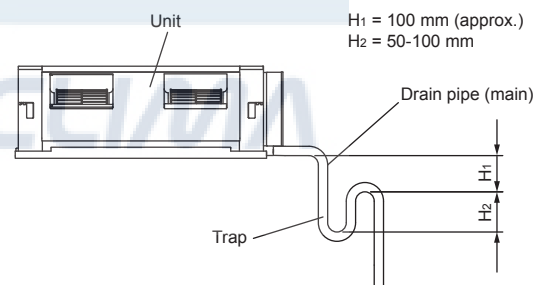

(2) Safety drain

There is no need to provide a trap for the safety drain pipe. If the safety drain pipe is connected to the main drain pipe, make the connection below the trap on the main drain pipe.

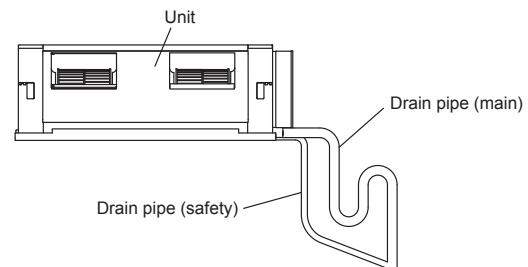

- Once installation is complete, check the flow of the drain water.

6. ELECTRICAL WIRING

Cable	Cable size (mm ²)	Type	Remarks
Connection cable	1.5 (MIN.)	Type 60245 IEC57	3Cable+earth (ground), 1φ230V

Max. Cable Length: Limit voltage drop to less than 2%. Increase cable gauge if voltage drop is 2% or more.

- Install all electrical works in accordance to standard.
- Install the disconnect device with a contact gap of at least 3mm in all poles nearby the units. (Both indoor unit and outdoor unit)
- Wiring size must comply with the applicable country or region's regulations.

⚠ WARNING

- Electrical work must be performed in accordance with this Manual by a person certified under the national or regional regulations. Be sure to use a dedicated circuit for the unit.
An insufficient power supply circuit or improperly performed electrical work can cause serious accidents such as electric shock or fire.
- Before starting work, check that power is not being supplied to the indoor unit and outdoor unit.
- For wiring, use the prescribed type of cables, connect them securely, making sure that there are no external forces of the cables applied to the terminal connections. Improperly connected or secured cables can cause serious accidents such as overheating the terminals, electric shock, or fire.
- Securely install the electrical box cover on the unit.
An improperly installed electrical box cover can cause serious accidents such as electric shock or fire through exposure to dust or water.
- Install sleeves into any holes made in the walls for wiring. Otherwise, a short circuit could result.
- Use the included connection cables and power cables or ones specified by the manufacturer. Improper connections, insufficient insulation, or exceeding the allowable current can cause electric shock or fire.
- Do not modify the power cables, use extension cables, or use any branches in the wiring. Improper connections, insufficient insulation, or exceeding the allowable current can cause electric shock or fire.
- Match the terminal block numbers and connection cable colors with those of the outdoor unit. Erroneous wiring may cause burning of the electric parts.
- Securely connect the connection cables to the terminal board. In addition, secure the cables with wiring holders. Improper connections, either in the wiring or at the ends of the wiring, can cause a malfunction, electric shock, or fire.
- Always fasten the outside covering of the connection cable with the cable clamp. (If the insulator is chafed, electric leakage may occur.)
- Install a earth leakage breaker. In addition, install the earth leakage breaker so that the entire AC main power supply is cut off at the same time. Otherwise, electric shock or fire could result.
- Always connect the earth (ground) cable.
Improper earthing (grounding) work can cause electric shocks.
- Install the remote controller cables so as not to be direct touched with your hand.
- Perform wiring work in accordance with standards so that the air conditioner can be operated safely and positively.
- Connect the connection cable firmly to the terminal board. Imperfect installation may cause a fire.

⚠ CAUTION

- Earth (Ground) the unit.
Do not connect the earth (ground) cable to a gas pipe, water pipe, lightning rod, or a telephone earth (ground) cable.
Improper earthing (grounding) may cause electric shock.
- Do not connect power supply cables to the transmission or remote controller terminals, as this will damage the product.
- Never bundle the power supply cable and transmission cable, remote controller cable together.
Separate these cable by 50 mm or more.
Bundling these cables together will cause miss operation or breakdown.
- When handling PCB, static electricity charged in the body may cause malfunction of the PCB. Follow the cautions below:
 - Establish a ground for the indoor and outdoor units and peripheral devices.
 - Cut power (breaker) off.
 - Touch metal part of the indoor and outdoor units for more than 10 seconds to discharge static electricity charged in the body.
 - Do not touch terminals of parts and patterns implemented on PCB.

- (1) Use ring terminals with insulating sleeves as shown in the figure below to connect to the terminal block.
- (2) Securely clamp the ring terminals to the cables using an appropriate tool so that the cables do not come loose.
- (3) Use the specified cables, connect them securely, and fasten them so that there is no stress placed on the terminals.
- (4) Use an appropriate screwdriver to tighten the terminal screws.
Do not use a screwdriver that is too small, otherwise, the screw heads may be damaged and prevent the screws from being properly tightened.
- (5) Do not tighten the terminal screws too much, otherwise, the screws may break.
- (6) See the table for the terminal screw tightening torques.
- (7) Please do not fix 2 power supply cables with 1 screw.

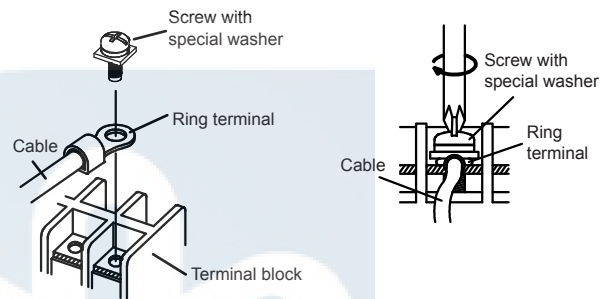
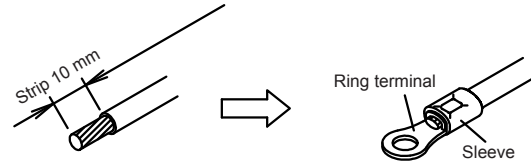

⚠ WARNING

- Use ring terminals and tighten the terminal screws to the specified torques, otherwise, abnormal overheating may be produced and possibly cause heavy damage inside the unit.

Tightening torque [N·m (kgf·cm)]

M4 screw	1.2 to 1.8 (12 to 18)
M5 screw	2.0 to 3.0 (20 to 30)

6.1. Wiring system diagram

- Connection cable (to outdoor unit)

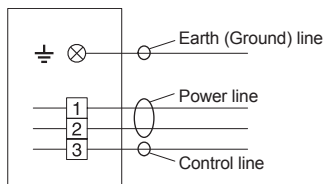

- Wired remote controller cable

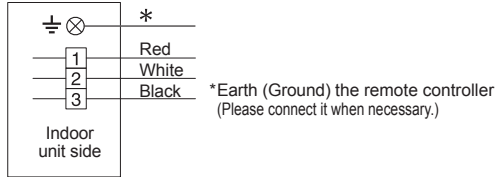

CAUTION

Tighten the indoor unit connection cable and power supply indoor and outdoor unit, terminal board connections firmly with the terminal board screws. Faulty connection may cause a fire.

If the indoor unit connection cable and power supply are wired incorrectly, the air conditioner may be damaged.

Connect the indoor unit connection cable by matching the numbers of the outdoor and indoor units terminal board numbers as shown in terminal label.

Earth (Ground) both the indoor and outdoor units by attaching an earth (ground) cable.

Unit shall be grounded in compliance with the country or region's regulations.

CAUTION

Be sure to refer to the above diagram for do correct field wiring. Wrong wiring causes malfunction of the unit.

Check local electrical rules and also any specific wiring instructions or limitation.

6.2. Connection cable preparation

Keep the earth (ground) wire longer than the other wires.

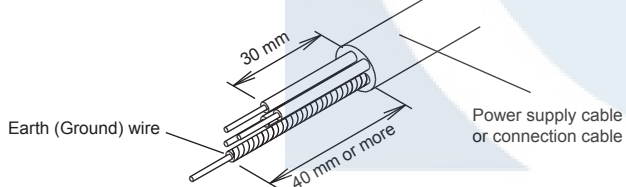

- Use a 4-core wire cable.

6.3. Connection of wiring

CAUTION

- Use care not to mistake the power supply cable and connection wires when installing.

- Install so that the wires for the remote controller will not come in contact with other connection wires.

- (1) Remove the control box cover and install each connection wire.

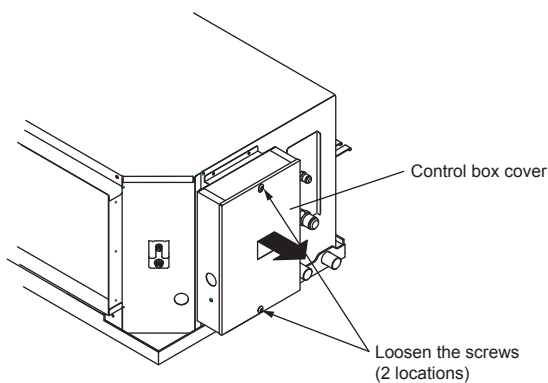

- (2) After wiring is complete, secure the remote controller cable, connection cable, and power supply cable with the cable clamps.
- (3) Install the control box cover.

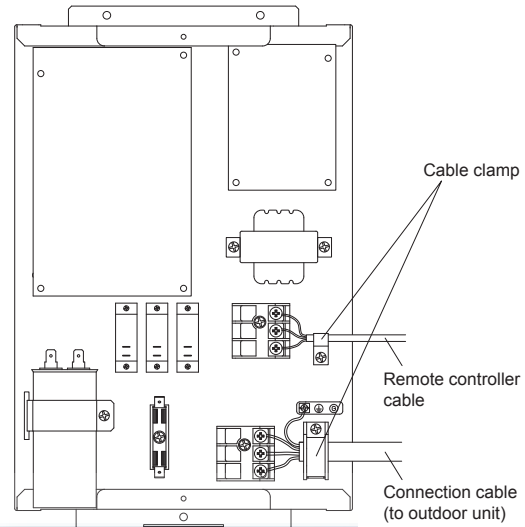

CAUTION

- Do not bundle the remote controller cable, or wire the remote controller cable in parallel, with the indoor unit connection wire (to the outdoor unit) and the power supply cable. It may cause erroneous operation.

7. REMOTE CONTROLLER SETTING

CAUTION

When detecting the room temperature using the remote controller, please set up the remote controller according to the following conditions. If the remote controller is not located properly, the correct room temperature will not be detected, and thus abnormal conditions like "not cooled" or "not heated" will occur even if the air-conditioner is running normally.

- Locate where an average temperature for the room being air conditioned will be sensed.
- Do not locate directly exposed to the outlet air from the air-conditioner.
- Locate out of direct sunlight.
- Locate away from the influence of other heat sources.

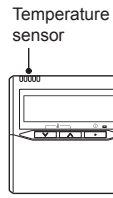

Do not touch the remote controller PC board and PC board parts directly with your hands.

Do not wire the remote controller cable together with or parallel to the connection cables, and power supply cable of the INDOOR UNIT and OUTDOOR UNIT. It may cause erroneous operation.

When installing the bus wire near a source of electromagnetic waves, use shielded wire.

Do not set the DIP switches, either on the air conditioner or the remote controller, in any way other than indicated in this manual that is supplied with the air conditioner. Doing so may result in improper operation.

7.1. Installing the remote controller

Open the operation panel on the front of the remote controller, remove the 2 screws indicated in the following figure, and then remove the front case of the remote controller.

When installing the remote controller, remove the connector from the front case. The wires may break if the connector is not removed and the front case hangs down. When installing the front case, connect the connector to the front case.

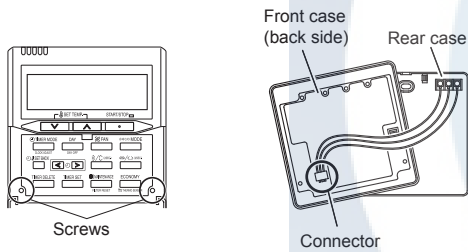

When remote controller cable is concealed

- (1) Conceal the remote controller cable.
- (2) Pass the remote controller cable through the hole in the rear case and connect the remote controller cable to the remote controller terminal board specified in figure.
- (3) Clamp the remote controller cable sheath with the cable tie as shown in figure.
- (4) Cut off the excess cable tie.
- (5) Install the rear case to the wall, box, etc., with 2 screws figure.

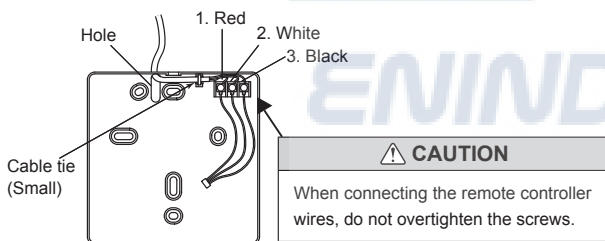

[Example]

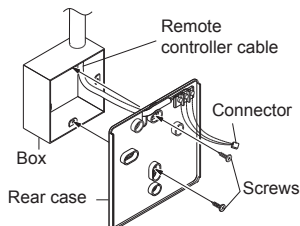

Ground the remote controller if it has a ground wire.

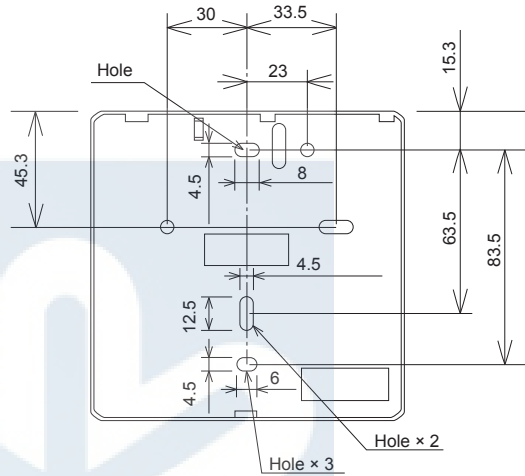
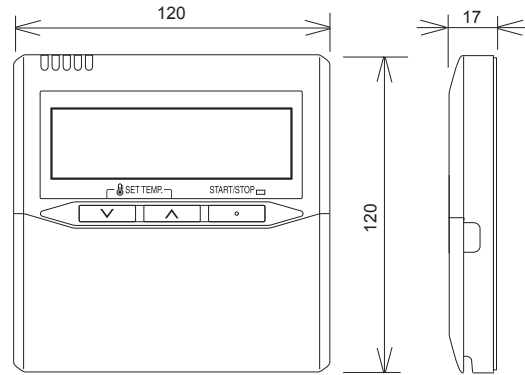
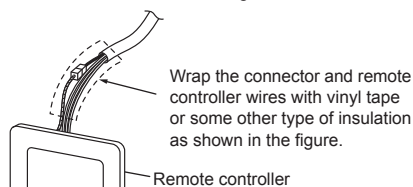

Unit: mm

CAUTION

Install the remote controller wires so as not to be direct touched with your hands.

Do not touch the remote controller PC board and PC board parts directly with your hands.

7.2. Setting the dip switches

Set the remote controller DIP switches.

[Example]

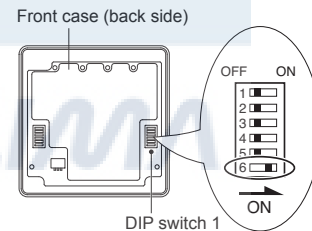

NO.	SW state		Detail
	OFF	ON	
1	★		Cannot be used. (Do not change)
2	★		Dual remote controller setting * Refer to 8.4. Dual remote controllers
3	★		Cannot be used. (Do not change)
4	★		Cannot be used. (Do not change)
5	★		Cannot be used. (Do not change)
6	★ Invalidity	Validity	Memory backup setting * Set to ON to use batteries for the memory backup. If batteries are not used, all of the settings stored in memory will be deleted if there is a power failure.

(★ Factory setting)

8. FUNCTION SETTING

CAUTION

- Confirm whether the wiring work for outdoor unit has been finished.
- Confirm whether the cover for electric control box on the outdoor unit is close.

8.1. Turning on the power

- (1) Check the remote controller wiring and DIP switch settings.
- (2) Install the front case.
When installing the front case, connect the connector to the front case.
- (3) Check the indoor and outdoor unit wiring and circuit board switch settings, and then turn on the indoor and outdoor units. After "9C" has flashed on the set temperature display for several seconds, the clock display will appear in the center of the remote controller display. The clock display will appear in the center of the remote controller display.



8.2. Function setting

This procedure changes the function settings used to control the indoor unit according to the installation conditions. Incorrect settings can cause the indoor unit to malfunction. This procedure should be performed by authorized installation or service personnel only. Perform the "FUNCTION SETTING" according to the installation conditions using the remote controller. (Refer to the indoor unit installation manual for details on the function numbers and setting values.)

- (1) Press the SET TEMP. buttons (V) (Λ) and FAN button simultaneously for more than 5 seconds to enter the function setting mode.

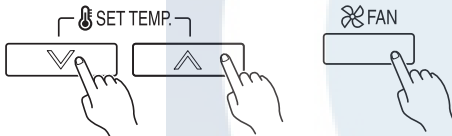

- (2) Press the SET BACK button to select the indoor unit number.

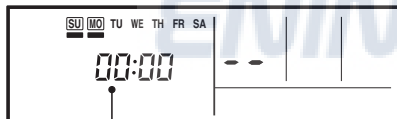

Unit number of INDOOR UNIT

- (3) Press the SET TIME (<) (>) buttons to select the function number.

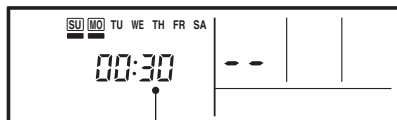
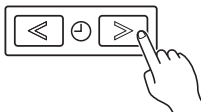

Function number

- (4) Press the SET TEMP. buttons (V) (Λ) to select the setting value. The display flashes as shown to the right during setting value selection.

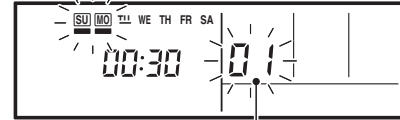
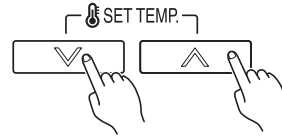

Setting value

- (5) Press the TIMER SET button to confirm the setting. Press the TIMER SET button for a few seconds until the setting value stops flashing. If the setting value display changes or if "-" is displayed when the flashing stops, the setting value has not been set correctly. (An invalid setting value may have been selected for the indoor unit.)
- (6) Repeat steps 2 to 5 to perform additional settings. Press the SET TEMP. buttons (V) (Λ) and FAN button simultaneously again for more than 5 seconds to cancel the function setting mode. In addition, the function setting mode will be automatically canceled after 1 minute if no operation is performed.
- (7) After completing the FUNCTION SETTING, be sure to turn off the power and turn it on again.

CAUTION

- After turning off the power, wait 30 seconds or more before turning on it again. The FUNCTION SETTING doesn't become effective if it doesn't do so.

• Function Details

(1) Filter Sign

The indoor unit has a sign to inform the user that it is time to clean the filter. Select the time setting for the filter sign display interval in the table below according to the amount of dust or debris in the room. If you do not wish the filter sign to be displayed, select the setting value for "No indication".

(♦... Factory setting)

Setting description	Function number	Setting value
Standard (2500 hours)	11	00
Long interval (5000 hours)		01
Short interval (1250 hours)		02
♦ No indication		03

(2) Cooling room temperature correction

Depending on the installed environment, the room temperature sensor may require a correction.

The settings may be selected as shown in the table below.

(♦... Factory setting)

Setting description	Function number	Setting value
♦ Standard	30	00
Warmer control		01
Slightly lower control		02
Lower control		03

(3) Heating room temperature correction

Depending on the installed environment, the room temperature sensor may require a correction.

The settings may be changed as shown in the table below.

(♦... Factory setting)

Setting description	Function number	Setting value
♦ Standard	31	00
Warmer control		01
Slightly warmer control		02
Lower control		03

(4) Auto restart

Enable or disable automatic system restart after a power outage.

(◆... Factory setting)

Setting description	Function number	Setting value
◆ Yes	40	00
No		01

* Auto restart is an emergency function such as for power failure etc. Do not start and stop the indoor unit by this function in normal operation. Be sure to operate by the control unit, or external input device.

(5) Indoor room temperature sensor switching function

(Only for Wired remote controller)

The following settings are needed when using the Wired remote controller temperature sensor.

(◆... Factory setting)

Setting description	Function number	Setting value
◆ No	42	00
Yes		01

* If setting value is "00":

Room temperature is controlled by the indoor unit temperature sensor.

* If setting value is "01":

Room temperature is controlled by either indoor unit temperature sensor or remote controller unit sensor.

(6) External input control

"Operation/Stop" mode or "Forced stop" mode can be selected.

(◆... Factory setting)

Setting description	Function number	Setting value
◆ Operation/Stop mode	46	00
(Setting forbidden)		01
Forced stop mode		02

(7) Room temperature control switching

• This setting is used to set the room temperature control method when the wired remote controller is selected by the Indoor Room Temperature Sensor Switching Function.

(◆... Factory setting)

Setting description	Function number	Setting value
◆ Control by the sensors of both the indoor unit and the wired remote controller.	48	00
Control only by the sensor of the wired remote controller		01

Setting record

• Record any changes to the settings in the following table.

Setting	Setting Value
(1) Filter sign	
(2) Cooling room temperature correction	
(3) Heating room temperature correction	
(4) Auto restart	
(5) Indoor room temperature sensor switching function	
(6) External input control	
(7) Room temperature control switching	

After completing the FUNCTION SETTING, be sure to turn off the power and turn it on again.

SETTING THE ROOM TEMPERATURE DETECTION LOCATION

The detection location of the room temperature can be selected from the following 2 examples. Choose the detection location that is best for the installation location.

A. Indoor unit setting (factory setting)

The room temperature is detected by the indoor unit temperature sensor.

(1) When the THERMO SENSOR button is pressed, the lock display flashes because the function is locked at the factory.

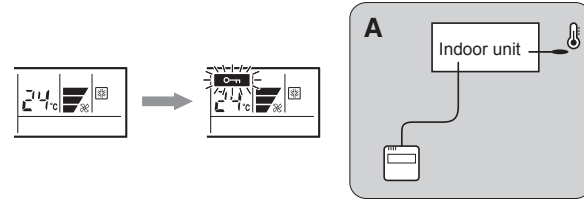

B. Indoor unit/remote controller setting (room temperature sensor selection)

The temperature sensor of the indoor unit or the remote controller can be used to detect the room temperature.

(1) Enable the room temperature sensor selection in FUNCTION SETTING, which will be "(5) Indoor room temperature sensor switching function".
 (2) Press the THERMO SENSOR button for 5 seconds or more to select the temperature sensor of the indoor unit or the remote controller.

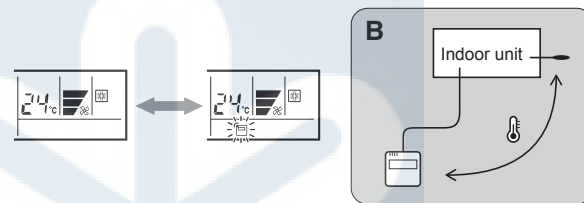

CAUTION

- When select the "Remote controller setting", if the detected temperature value between the temperature sensor of the indoor unit and the temperature sensor of the remote controller varies significantly, it is likely to return to the control status of temperature sensor of the indoor unit temporarily.
- As the temperature sensor of remote controller detects the temperature near the wall, when there is a certain difference between the room temperature and the wall temperature, the sensor will not detect the room temperature correctly sometimes. Especially when the outer side of the wall on which the sensor is positioned is exposed to the open air, it is recommended to use the temperature sensor of the indoor unit to detect the room temperature when the indoor and outdoor temperature difference is significant.
- The temperature sensor of the remote controller is not only used when there is a problem in the detection of the temperature sensor of the indoor unit.

NOTES

If the function to change the temperature sensor is used as shown in examples A (other than example B), be sure to lock the detection location. If the function is locked, the lock display  will flash when the THERMO SENSOR button is pressed.

8.3. Group control system

CAUTION

- When setting rotary switch, do not touch any other parts on the circuit board directly with your bare hands.
- Be sure to turn off the main power.

A number of indoor units can be operated at the same time using a single remote controller.

(1) Wiring method (indoor unit to remote controller)

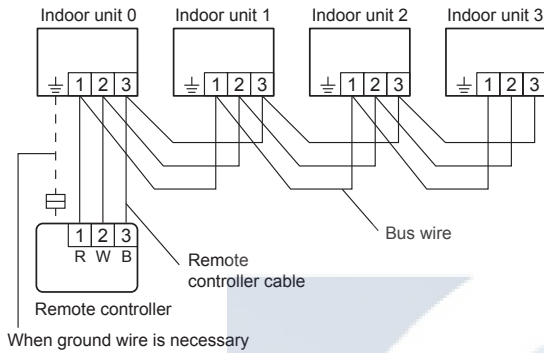

(2) Rotary switch setting (indoor unit)

Set the unit number of each indoor unit using the rotary switch on the indoor unit circuit board. The rotary switch is normally set to 0.

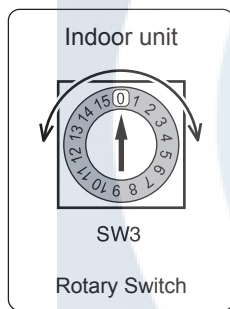

NOTE

Be sure to set the unit numbers sequentially.

(3) Remote controller setting

1. Turn on all of the indoor units.
 - * Turn on the indoor unit with the unit number 00 last. (Within 1 minute)
2. Set the refrigerant circuit address. (Assign the same number to all of the indoor units connected to an outdoor unit.)

Refrigerant circuit address	Function Number	Setting Value
	02	00~15

3. Set the "primary" and "secondary" settings. (Set the indoor unit that is connected to the outdoor unit using a transmission cable as the "primary".)

	Function Number	Setting Value
Primary	51	00
Secondary		01

4. After completing the function settings, turn off all of the indoor units, and then turn them back on.
 - * If error code 21, 22, 24, or 27 is displayed, there may be an incorrect setting. Perform the remote controller setting again.

NOTE

- When different indoor unit models are connected using the group control system, some functions may no longer be available.
- If the group control system contains multiple units that are operated simultaneously, connect and set the units as shown below.
- Auto-changeover operates under the same mode with model unit number 00.
- It should not be connected to any other Gr that is not of the same series (A**G only).

Standard pair Simultaneous twin Simultaneous triple

	Standard pair	Simultaneous twin	Simultaneous triple
Remote controller	Outdoor unit ① Indoor unit	Outdoor unit ② Indoor unit Indoor unit	Outdoor unit ③ Indoor unit Indoor unit Indoor unit
Rotary switch setting (unit number)	00	01 02	03 04 05
Remote controller setting			
▪ Refrigerant circuit address	00	01 01	02 02 02
▪ Primary/Secondary	00	00 01	00 01 01

: Transmission cable, Power supply cable : Power supply cable
 : Remote controller cable : Bus wire

* Make sure that the indoor unit with the unit number 00 is connected to the outdoor unit using a transmission cable.

8.4. Dual remote controllers

- Two separate remote controllers can be used to operate the indoor units.
- The timer and self-diagnosis functions cannot be used on the secondary units.

(1) Wiring method (indoor unit to remote controller)

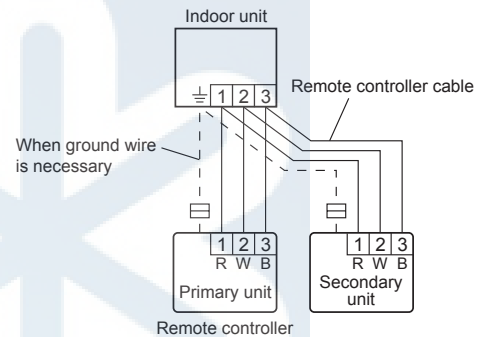

(2) Remote controller DIP switch 1 setting

Set the remote controller DIP switch 1 No. 2 according to the following table. (Refer to 7.2. Setting the dip switches)

Number of remote controllers	Primary unit	Secondary unit
	DIP SW 1 No. 2	DIP SW 1 No. 2
1 (Normal)	OFF	—
2 (Dual)	OFF	ON

9. TEST RUN

CHECK ITEMS

- (1) Is operation of each button on the remote controller normal?
- (2) Is the drain normal?
- (3) Is there any abnormal noise and vibration during operation?
 - Do not operate the air conditioner in test run for a long time.

[OPERATION METHOD]

- For the operation method, refer to the operating manual.
- (1) Stop the air conditioner operation.
 - (2) Press the MODE button and the FAN button simultaneously for 2 seconds or more to start the test run.

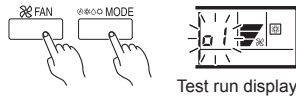

- (3) Press the START/STOP button to stop the test run. If "CO" appears in the unit number display, there is a remote controller error. Refer to the installation manual included with the remote controller.

Unit number	Error code	Content
CO	15	Incompatible indoor unit is connected
CO	12	Indoor unit ↔ remote controller communication error

10. CHECK LIST

Pay special attention to the check items below when installing the indoor unit(s). After installation is complete, be sure to check the following check items again.

CHECK ITEMS	If not performed correctly	CHECK BOX
Has the indoor unit been installed correctly?	Vibration, noise, indoor unit may drop	
Has there been a check for gas leaks (refrigerant pipes)?	No cooling, No heating	
Has heat insulation work been completed?	Water leakage	
Does water drain easily from the indoor units?	Water leakage	
Are the wires and pipes all connected completely?	No operation, heat or burn damage	
Is the connection cable the specified thickness?	No operation, heat or burn damage	
Are the inlets and outlets free of any obstacles?	No cooling, No heating	
After installation is completed, has the proper operation and handling been explained to the user?		

11. OPTIONAL KIT INSTALLATION (OPTION)

WARNING

Regulation of cable differs from each locality, refer in accordance with local rules.

This air conditioner can be connected with the following optional kits.

Option type	Connector No.
UTY-XSZX (Remote sensor unit)	CN8
UTD-ECS5A (External input)	CN114
UTD-ECS5A (External output)	CN115
UTD-ECS5A (Preparation)	CN5, CN106

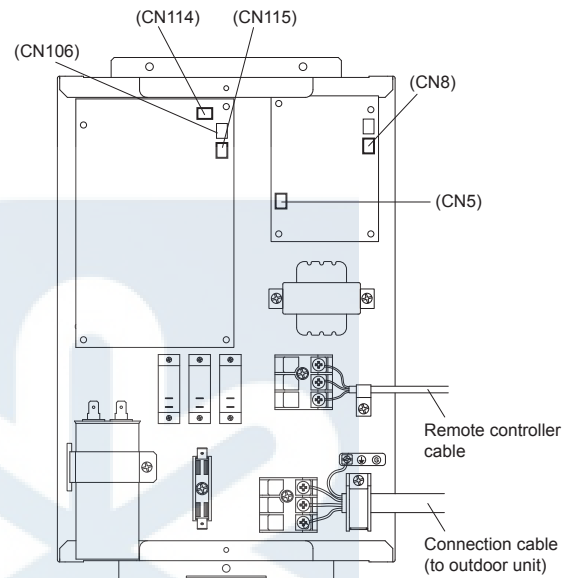

12. CUSTOMER GUIDANCE

Explain the following to the customer in accordance with the operating manual:

- (1) Starting and stopping method, operation switching, temperature adjustment, timer, air flow switching, and other remote controller operations.
- (2) Air filter removal and cleaning, and how to use the air louvers.
- (3) Give the operating and installation manuals to the customer.

13. ERROR CODES

[Troubleshooting at the remote controller LCD]

This is possible only on the wired remote controller.

[Self-diagnosis]

If an error occurs, the following display will be shown. ("Er" will appear in the set room temperature display.)

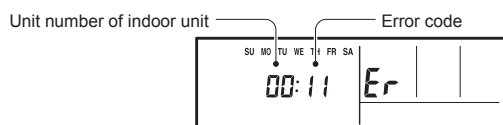

EX. Self-diagnosis

Wired remote controller Error code	Description
11	Serial communication error
12	Wired remote controller communication error
15	Check run unfinished
21	Unit number or Refrigerant circuit address setting error [Simultaneous Multi]
22	Indoor unit capacity error
23	Combination error
24	• Connection unit number error (indoor secondary unit) [Simultaneous Multi] • Connection unit number error (indoor unit or branch unit) [Flexible Multi]
27	Primary unit, secondary unit set-up error [Simultaneous Multi]
31	Power supply interruption error
32	Indoor unit PCB model information error
35	Manual auto switch error
41	Room temp. sensor error
42	Indoor unit Heat Ex. Middle temp. sensor error
51	Indoor unit fan motor error
53	Drain pump error
57	Damper error
5U	Indoor unit error
62	Outdoor unit main PCB model information error or communication error
63	Inverter error
64	Active filter error, PFC circuit error
65	Trip terminal L error
6A	Display PCB microcomputers communication error
71	Discharge temp. sensor error
72	Compressor temp. sensor error
73	Outdoor unit Heat Ex. liquid temp. sensor error
74	Outdoor temp. sensor error
75	Suction Gas temp. sensor error

76	• 2-way valve temp. sensor error • 3-way valve temp. sensor error
77	Heat sink temp. sensor error
82	• Sub-cool Heat Ex. gas inlet temp. sensor error • Sub-cool Heat Ex. gas outlet temp. sensor error
83	Liquid pipe temp. sensor error
84	Current sensor error
86	• Discharge pressure sensor error • Suction pressure sensor error • High pressure switch error
94	Trip detection
95	Compressor rotor position detection error (permanent stop)
97	Outdoor unit fan motor 1 error
98	Outdoor unit fan motor 2 error
99	4-way valve error
9A	Coil (expansion valve) error
A1	Discharge temp. error
A3	Compressor temp. error
A4	High pressure error
A5	Low pressure error
J2	Branch boxes error [Flexible Multi]



ENINDEL CLIMA

AIR CONDITIONER

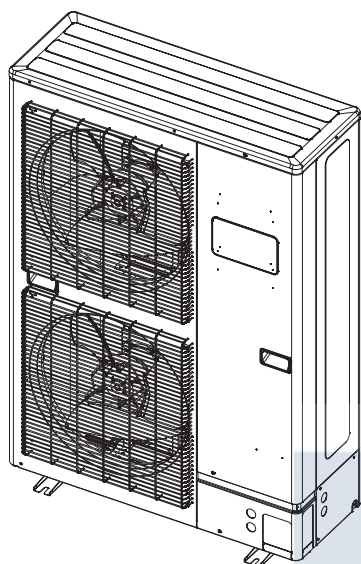

INSTALLATION MANUAL

OUTDOOR UNIT (3 Phase Type)

For authorized service personnel only.

English

INSTALLATIONSANLEITUNG

AUSSENGERÄT (3-Phasen-Typ)

Nur für autorisiertes Fachpersonal.

Deutsch

MANUEL D'INSTALLATION

APPAREIL EXTÉRIEUR (type 3 phases)

Pour le personnel d'entretien autorisé uniquement.

Français

MANUAL DE INSTALACIÓN

UNIDAD EXTERIOR (Tipo trifásico)

Únicamente para personal de servicio autorizado.

Español

MANUALE DI INSTALLAZIONE

UNITÀ ESTERNA (tipo a 3 fasi)

A uso esclusivo del personale tecnico autorizzato.

Italiano

ΕΓΧΕΙΡΙΔΙΟ ΕΓΚΑΤΑΣΤΑΣΗΣ

ΕΞΩΤΕΡΙΚΗ ΜΟΝΑΔΑ (Τριφασικού Τύπου)

Μόνο για εξουσιοδοτημένο τεχνικό προσωπικό.

Ελληνικά

MANUAL DE INSTALAÇÃO

UNIDADE EXTERIOR (Tipo trifásica)

Apenas para pessoal de assistência autorizado.

Português

РУКОВОДСТВО ПО УСТАНОВКЕ

ВНЕШНИЙ МОДУЛЬ (3-фазного типа)

Только для авторизованного обслуживающего персонала.

Русский

MONTAJ KILAVUZU

DIŞ ÜNİTE (3 Faz Tipi)

Yalnızca yetkili servis personeli için.

Türkçe

PART No. 9379069274-04

Contents

1. SAFETY PRECAUTIONS.....	2
2. ABOUT THE UNIT	
2.1. Precautions for using R410A refrigerant.....	2
2.2. Special tools for R410A.....	3
2.3. Accessories.....	3
3. INSTALLATION WORK	
3.1. Selecting an installation location.....	3
3.2. Drain installation.....	4
3.3. Installation dimensions.....	4
3.4. Transporting the unit.....	5
3.5. Installation.....	5
4. PIPE SELECTION	
4.1. Selecting the pipe material.....	5
4.2. Protection of pipes.....	5
4.3. Refrigerant pipe size and allowable piping length.....	5
4.4. Connectable pipe diameter and max. piping length.....	6
5. PIPE INSTALLATION-1	
5.1. Opening a knock out hole.....	7
5.2. Brazing.....	7
5.3. Indoor unit pipe connections.....	7
5.4. Flare connection (pipe connection).....	7
5.5. Sealing test.....	8
5.6. Vacuum process.....	8
5.7. Additional charging.....	9
6. ELECTRICAL WIRING	
6.1. Notes for electrical wiring.....	10
6.2. Selecting circuit breaker and wiring.....	11
6.3. Knock out holes for wiring.....	11
6.4. Wiring method.....	11
7. PIPE INSTALLATION-2	
7.1. Installing insulation.....	12
7.2. Filling with putty.....	12
8. HOW TO OPERATE DISPLAY UNIT	
8.1. Various setting methods.....	12
8.2. Description of display.....	13
9. LOCAL SETTING	
9.1. Low noise mode (Local work).....	13
9.2. Peak cut mode (Local work).....	14
10. TEST RUN	
10.1. Check items before performing the test run.....	14
10.2. Test run method.....	14
11. PUMP DOWN	
11.1. Preparation for pump down.....	15
11.2. Pump down procedure.....	15
12. ERROR CODE DISPLAY	
12.1. How to check error code.....	16
12.2. Error code check table.....	16

1. SAFETY PRECAUTIONS

- Be sure to read this manual carefully before installation.
- The warnings and precautions indicated in this manual contain important information pertaining to your safety. Be sure to observe them.
- Hand this manual, together with the operating manual, to the customer. Request the customer to keep them on hand for future use, such as for relocating or repairing the unit.

⚠ WARNING This mark indicates procedures which, if improperly performed, might lead to the death or serious injury of the user.

⚠ CAUTION This mark indicates procedures which, if improperly performed, might possibly result in personal harm to the user, or damage to property.

⚠ WARNING

Never touch electrical components immediately after the power supply has been turned off. Electrical shock may occur. After turning off the power, always wait 10 minutes or more before touching electrical components.

Request your dealer or a professional installer to install the outdoor unit in accordance with this installation manual. An improperly installed unit can cause serious accidents such as water leakage, electric shock, or fire. If the outdoor unit is installed in disregard of the instructions in the installation manual, it will void the manufacturer's warranty.

Do not turn ON the power until all work has been completed. Turning ON the power before the work is completed can cause serious accidents such as electric shock or fire.

If refrigerant leaks while work is being carried out, ventilate the area. If the refrigerant comes in contact with a flame, it produces a toxic gas.

Installation work must be performed in accordance with national wiring standards by authorized personnel only.

⚠ WARNING

Do not use this equipment with air or any other unspecified refrigerant in the refrigerant lines.

Excess pressure can cause a rupture.

During installation, make sure that the refrigerant pipe is attached firmly before you run the compressor.

Do not operate the compressor under the condition of refrigerant piping not attached properly with 2-way or 3-way valve open. This may cause abnormal pressure in the refrigeration cycle that leads to rupture and even injury.

When installing and relocating the air conditioner, do not mix gases other than the specified refrigerant (R410A) to enter the refrigerant cycle. If air or other gas enters the refrigerant cycle, the pressure inside the cycle will rise to an abnormally high value and cause rupture, injury, etc.

For the air conditioner to operate satisfactorily, install it as outlined in this installation manual.

Connect the indoor unit and outdoor unit with the air conditioner piping and cable available standards parts.

This installation manual describes the correct connections using the installation set available from our standard parts.

Also, do not use an extension cable.

Do not purge the air with refrigerants but use a vacuum pump to vacuum the installation.

There is not extra refrigerant in the outdoor unit for air purging.

Use a vacuum pump for R410A exclusively.

Using the same vacuum pump for different refrigerants may damage the vacuum pump or the unit.

Use a clean gauge manifold and charging hose for R410A exclusively.

During the pump-down operation, make sure that the compressor is turned off before you remove the refrigerant piping.

Do not remove the connection pipe while the compressor is in operation with 2 way or 3 way valve open. This may cause abnormal pressure in the refrigeration cycle that leads to rupture and even injury.

⚠ CAUTION

Read carefully all security information before use or install the air conditioner.

Do not attempt to install the air conditioner or a part of the air conditioner by yourself.

This unit must be installed by qualified personnel with a capacity certificate for handling refrigerant fluids. Refer to regulation and laws in use on installation place.

The installation must be carried out in compliance with regulations in force in the place of installation and the installation instructions of the manufacturer.

This unit is part of a set constituting an air conditioner. It must not be installed alone or with non-authorized by the manufacturer.

Always use a separate power supply line protected by a circuit breaker operating on all wires with a distance between contact of 3mm for this unit.

The unit must be correctly earthed (grounded) and the supply line must be equipped with a differential breaker in order to protect the persons.

The units are not explosion proof and therefore should not be installed in explosive atmosphere.

This unit contains no user-serviceable parts. Always consult authorized service personnel to repairs.

When moving, consult authorized service personnel for disconnection and installation of the unit.

Children should be monitored to ensure they do not play with the device.

This appliance is not intended for use by persons (including children) with reduced physical, sensory or mental capabilities, or lack of experience and knowledge, unless they have been given supervision or instruction concerning use of the appliance by a person responsible for their safety. Children should be supervised to ensure that they do not play with the appliance.

Do not touch the aluminum fins of heat exchanger built-in the indoor or outdoor unit to avoid personal injury when you install or maintain the unit.

Do not place any other electrical products or household belongings under indoor unit or outdoor unit. Dripping condensation from the unit might get them wet, and may cause damage or malfunction of your property.

2. ABOUT THE UNIT

2.1. Precautions for using R410A refrigerant

⚠ WARNING

Do not introduce any substance other than the prescribed refrigerant into the refrigeration cycle. If air enters the refrigeration cycle, the pressure in the refrigeration cycle will become abnormally high and cause the piping to rupture.

If there is a refrigerant leak, make sure that it does not exceed the concentration limit. If a refrigerant leak exceeds the concentration limit, it can lead to accidents such as oxygen starvation.

⚠ WARNING
Do not touch refrigerant that has leaked from the refrigerant pipe connections or other areas. Touching the refrigerant directly can cause frostbite.
If a refrigerant leak occurs during operation, immediately vacate the premises and thoroughly ventilate the area. If the refrigerant comes in contact with a flame, it produces a toxic gas.
The basic installation work procedures are the same as conventional refrigerant models. However, pay careful attention to the following points:
<ul style="list-style-type: none"> Since the working pressure is 1.6 times higher than that of conventional refrigerant (R22) models, some of the piping and installation and service tools are special. (See the table below.) Especially, when replacing a conventional refrigerant (R22) model with a new refrigerant R410A model, always replace the conventional piping and flare nuts with the R410A piping and flare nuts. Models that use refrigerant R410A have a different charging port thread diameter to prevent erroneous charging with conventional refrigerant (R22) and for safety. Therefore, check beforehand. [The charging port thread diameter for R410A is 1/2 UNF 20 threads per inch.] Be careful that foreign matter (oil, water, etc.) does not enter the piping than with refrigerant models. Also, when storing the piping, securely seal the openings by pinching, taping, etc. When charging the refrigerant, take into account the slight change in the composition of the gas and liquid phases. And always charge from the liquid phase where refrigerant composition is stable.

2.2. Special tools for R410A

⚠ WARNING
To install a unit that uses R410A refrigerant, use dedicated tools and piping materials that have been manufactured specifically for R410A use. Because the pressure of R410A refrigerant is approximately 1.6 times higher than R22, failure to use dedicated piping material or improper installation can cause rupture or injury. Furthermore, it can cause serious accidents such as water leakage, electric shock, or fire.

Tool name	Changes
Gauge manifold	Pressure is high and cannot be measured with a conventional gauge. To prevent erroneous mixing of other refrigerants, the diameter of each port has been changed. It is recommended the gauge with seals -0.1 to 5.3 MPa (-1 to 53 bar) for high pressure. -0.1 to 3.8 MPa (-1 to 38 bar) for low pressure.
Charging hose	To increase pressure resistance, the hose material and base size were changed.
Vacuum pump	A conventional vacuum pump can be used by installing a vacuum pump adapter.
Gas leakage detector	Special gas leakage detector for HFC refrigerant R410A.

Copper pipes

It is necessary to use seamless copper pipes and it is desirable that the amount of residual oil is less than 40 mg/10 m. Do not use copper pipes having a collapsed, deformed or discolored portion (especially on the interior surface). Otherwise, the expansion valve or capillary tube may become blocked with contaminants.
As an air conditioner using R410A incurs pressure higher than when using conventional refrigerant, it is necessary to choose adequate materials.
Thicknesses of copper pipes used with R410A are as shown in the table. Never use copper pipes thinner than that in the table even when it is available on the market.

Thicknesses of Annealed Copper Pipes (R410A)





Pipe outside diameter [mm (in.)]	Thickness [mm]
6.35 (1/4)	0.80
9.52 (3/8)	0.80
12.70 (1/2)	0.80
15.88 (5/8)	1.00
19.05 (3/4)	1.20

2.3. Accessories

⚠ WARNING
For installation purposes, be sure to use the parts supplied by the manufacturer or other prescribed parts. The use of non-prescribed parts can cause serious accidents such as the unit falling, water leakage, electric shock, or fire.

Following installation parts are supplied. Use them as required.

Keep this manual in a safe place, and do not discard any other accessories until the installation work has been completed.

Name and shape	Q'ty	Description
Installation manual 	1	This manual
Drain pipe 	1	For outdoor unit drain piping work (May not be supplied, depending on the model.)
Drain cap 	2	
One-touch bush 	2	For power supply cable and connection cable installation

3. INSTALLATION WORK

Make sure to obtain the customer's approval for selecting and installing the outdoor unit.

3.1. Selecting an installation location

⚠ WARNING
Securely install the outdoor unit at a location that can withstand the weight of the unit. Otherwise, the outdoor unit may fall and cause injury.
Be sure to install the outdoor unit as prescribed, so that it can withstand earthquakes and typhoons or other strong winds. Improper installation can cause the unit to topple or fall, or other accidents.
Do not install the outdoor unit near the edge of a balcony. Otherwise, children may climb onto the outdoor unit and fall off of the balcony.

⚠ CAUTION
Do not install the outdoor unit in the following areas: <ul style="list-style-type: none"> Area with high salt content, such as at the seaside. It will deteriorate metal parts, causing the parts to fail or the unit to leak water. Area filled with mineral oil or containing a large amount of splashed oil or steam, such as a kitchen. It will deteriorate plastic parts, causing the parts to fail or the unit to leak water. Area that generates substances that adversely affect the equipment, such as sulfuric gas, chlorine gas, acid, or alkali. It will cause the copper pipes and brazed joints to corrode, which can cause refrigerant leakage. Area containing equipment that generates electromagnetic interference. It will cause the control system to malfunction, preventing the unit from operating normally. Area that can cause combustible gas to leak, contains suspended carbon fibers or flammable dust, or volatile inflammables such as paint thinner or gasoline. If gas leaks and settles around the unit, it can cause a fire. Area where small animals may live. It may cause failure, smoke or fire if small animals enter and touch internal electrical parts. Area where animals may urinate on the unit or ammonia may be generated.
Do not tilt the outdoor unit more than 3 degrees.
Install the outdoor unit in a well-ventilated location away from rain or direct sunlight.
If the outdoor unit must be installed in an area within easy reach of the general public, install as necessary a protective fence or the like to prevent their access.
Install the outdoor unit in a location that would not inconvenience your neighbors, as they could be affected by the airflow coming out from the outlet, noise, or vibration. If it must be installed in proximity to your neighbors, be sure to obtain their approval.
If the outdoor unit is installed in a cold region that is affected by snow accumulation, snow fall, or freezing, take appropriate measures to protect it from those elements. To ensure a stable operation, install inlet and outlet ducts.
Install the outdoor unit in a location that is away from exhaust or the vent ports that discharge vapor, soot, dust, or debris.
Install the indoor unit, outdoor unit, power supply cable, transmission cable, and remote control cable at least 1 m away from a television or radio receivers. The purpose of this is to prevent TV reception interference or radio noise. (Even if they are installed more than 1 m apart, you could still receive noise under some signal conditions.)

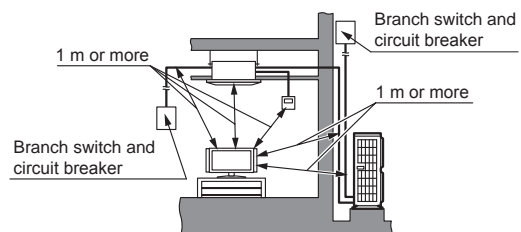

CAUTION

If children under 10 years old may approach the unit, take preventive measures so that they cannot reach the unit.

Keep the length of the piping of the indoor and outdoor units within the allowable range.

For maintenance purposes, do not bury the piping.

3.2. Drain installation

CAUTION

Perform drain work in accordance with this Manual, and ensure that the drain water is properly drained. If the drain work is not carried out correctly, water may drip down from the unit, wetting the furniture.

When the outdoor temperature is 0 °C or less, do not use the accessory drain pipe and drain cap. If the drain pipe and drain cap are used, the drain water in the pipe may freeze in extremely cold weather. (Reverse cycle model only)

- As the drain water flows out of the outdoor unit during heating operation, install the drain pipe and connect it to a commercial 16 mm hose. (Reverse cycle model only)
- When installing the drain pipe, plug all the holes other than the drain pipe mounting hole in the bottom of the outdoor unit with putty so there is no water leakage. (Reverse cycle model only)

(Unit : mm)

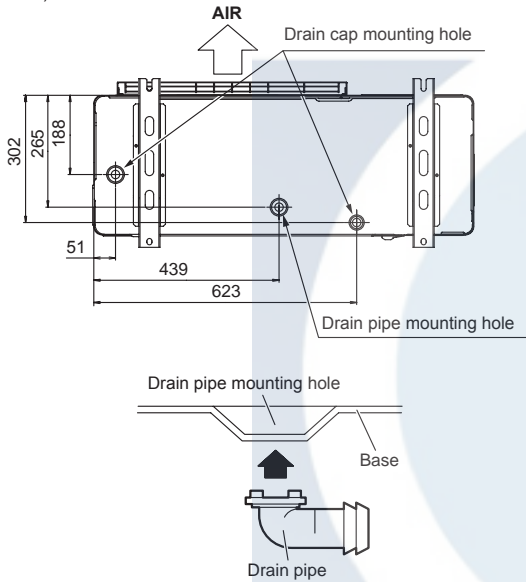

3.3. Installation dimensions

CAUTION

The installation space shown in the following examples is based on an ambient temperature under cooling operation of 35 °C (DB) at the air intake of the outdoor unit. Provide more space around the air intake than shown in the examples if the ambient temperature exceeds 35 °C (DB) or if the thermal load of all of the outdoor units exceeds the capacity.

Consider the transportation route, installation space, maintenance space, and access, and install the unit in a location with sufficient space for the refrigerant piping.

Observe the installation space specifications that are shown in the figures. Keep the same space at rear air intake. Provide the same space for the air intake at the rear of the outdoor unit. If the installation is not performed according to the specifications, it could cause a short circuit and result in a lack of operating performance. As a result, the outdoor unit might easily be stopped by high-pressure protection.

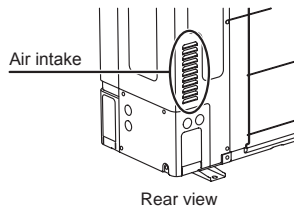

Installation methods not shown in the following examples are not recommended. Performance may drop significantly.

3.3.1. Single outdoor unit installation

When the upward area is open (Unit : mm)

(1) Obstacles at rear only

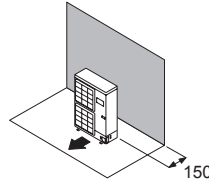

(2) Obstacles at rear and sides only

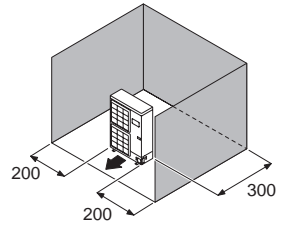

(3) Obstacles at front only

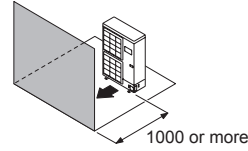

(4) Obstacles at front and rear only

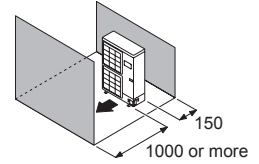

When an obstruction is present also in the upward area (Unit : mm)

(1) Obstacles at rear and above only

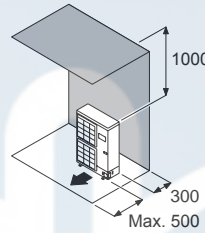

(2) Obstacles at rear, sides, and above only

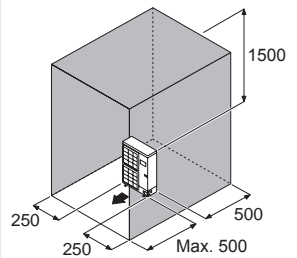

3.3.2. Multiple outdoor unit installation

- Provide at least 15 mm of space between the outdoor units if multiple units are installed.
- When routing the piping from the side of an outdoor unit, provide space for the piping.
- No more than 3 units must be installed side by side. When 3 units or more are arranged in a line, provide the space as shown in the following example when an obstruction is present also in the upward area.

When the upward area is open (Unit : mm)

(1) Obstacles at rear only

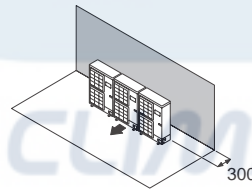

(2) Obstacles at front only

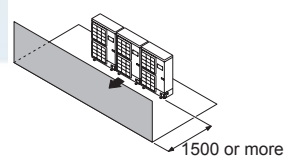

(3) Obstacles at front and rear only

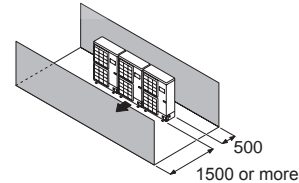

When an obstruction is present also in the upward area (Unit : mm)

Obstacles at rear and above only

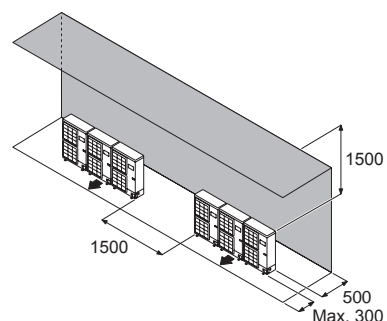

3.3.3. Outdoor units installation in multi row (Unit : mm)

(1) Single parallel unit arrangement

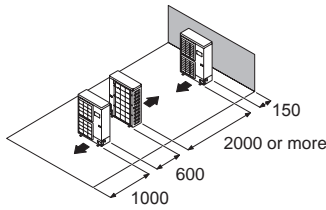

(2) Multiple parallel unit arrangement

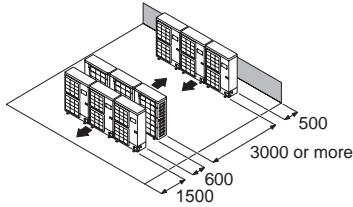

3.4. Transporting the unit

⚠ WARNING

Do not touch the fins.
Otherwise, personal injury could result.

⚠ CAUTION

When carrying the unit, hold the handles on the right and left sides and be careful. If the outdoor unit is carried from the bottom, hands or fingers may be pinched.

- Carry slowly in the manner as shown on "Fig. B" holding the handles "Fig. A" in right and left sides. (Be careful not to touch with hands or objects.)
- Be sure to hold the handles on the sides of the unit. Otherwise, the suction grilles on the sides of the unit may be deformed.

Fig. A

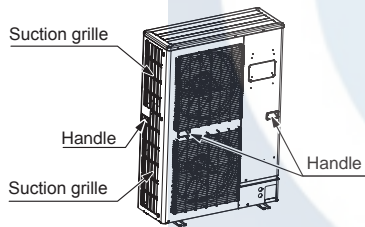
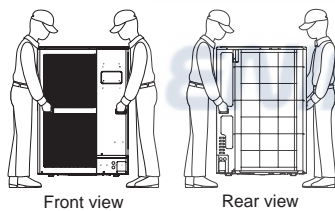
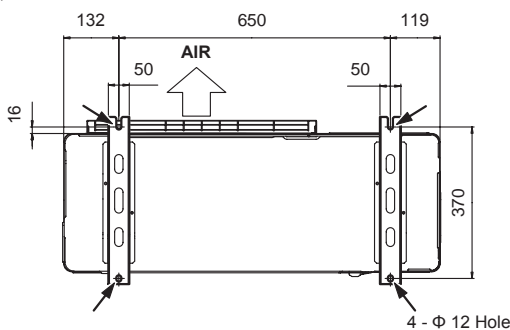

Fig. B



3.5. Installation

(Unit : mm)



- Install 4 anchor bolts at the locations indicated with arrows in the above figure.
- To reduce vibration, do not install the unit directly on the ground. Install it on a secure base (such as concrete blocks).

- The foundation shall support the legs of the unit and have a width of 50 mm or more.
- Depending on the installation conditions, the outdoor unit may spread its vibration during operation, which may cause noise and vibration. Therefore, attach damping materials (such as damping pads) to the outdoor unit during installation.
- Install the foundation, making sure that there is enough space for installing the connection pipes.
- Secure the unit to a solid block using foundation bolts. (Use 4 sets of commercially available M10 bolts, nuts, and washers.)
- The bolts should protrude 20 mm. (Refer to the figure below.)
- If overturning prevention is required, purchase the necessary commercially available items.

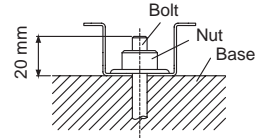

Fix securely with bolts on a solid block. (Use 4 sets of commercially available M10 bolt, nut and washer.)

4. PIPE SELECTION

4.1. Selecting the pipe material

⚠ CAUTION

Do not use existing pipes.

Use pipes that have clean external and internal sides without any contamination which may cause trouble during use, such as sulfur, oxide, dust, cutting waste, oil, or water.

It is necessary to use seamless copper pipes.

Material: Phosphor deoxidized seamless copper pipes.

It is desirable that the amount of residual oil is less than 40 mg/10 m.

Do not use copper pipes that have a collapsed, deformed, or discolored portion (especially on the interior surface). Otherwise, the expansion valve or capillary tube may become blocked with contaminants.

Improper pipe selection will degrade performance. As an air conditioner using R410A incurs pressure higher than when using conventional refrigerant, it is necessary to choose adequate materials.

Note:

Thicknesses of copper pipes used with R410A are as shown in the table.

Never use copper pipes thinner than those indicated in the table even if they are available on the market.

Thicknesses of Annealed Copper Pipes (R410A)

Pipe outside diameter [mm (in.)]	Thickness [mm]
6.35 (1/4)	0.8
9.52 (3/8)	
12.70 (1/2)	
15.88 (5/8)	1.0
19.05 (3/4)	1.2

4.2. Protection of pipes

Protect the pipes to prevent the entry of moisture and dust.

Especially, pay attention when passing the pipes through a hole or connecting the end of a pipe to the outdoor unit.

Location	Working period	Protection method
Outdoor	1 month or more	Pinch pipes
	Less than 1 month	Pinch or tape pipes
Indoor	-	Pinch or tape pipes

4.3. Refrigerant pipe size and allowable piping length

⚠ CAUTION

Keep the piping length between the indoor unit and outdoor unit within the allowable tolerance.

4.3.1. Single type installation

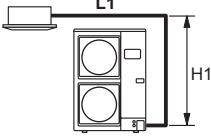
Capacity [Btu/h class]	36,000	45,000	54,000
Pipe diameter <Liquid/Gas> (Standard) [mm (in.)]	9.52 (3/8) / 15.88 (5/8)		
Max. piping length (L1) [m]	75 ^{*1}		
Min. piping length (L1) [m]	5		
Max. height difference (H1) <Indoor unit to outdoor unit> [m]	30		
View (Example)			

*1: For the standard pipe diameter.

4.3.2. Simultaneous operation multi type installation

 CAUTION	
Be certain to install indoor units in the same room because the combinations are for simultaneous operation.	
The lengths after branching should be equal if possible.	

Twin type

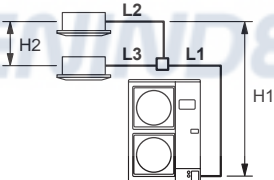
Capacity [Btu/h class]	36,000	45,000	54,000
Indoor unit capacity [Btu/h class]	18,000 + 18,000	22,000 + 22,000	24,000 + 24,000
Main pipe diameter (L1) <Liquid/Gas> (Standard) [mm (in.)]	9.52 (3/8) / 15.88 (5/8)		
Branch pipe diameter (L2, L3) <Liquid/Gas> [mm (in.)]	6.35 (1/4) / 12.70 (1/2)	9.52 (3/8) / 15.88 (5/8)	
Max. piping length (L1+L2+L3) [m]	75 ^{*1}		
Min. piping length (L1+L2+L3) [m]	5		
Max. branch piping length (L2, L3) [m]	20		
Max. difference between branch lengths (L2 to L3) [m]	8		
Max. height difference (H1) <Indoor unit to outdoor unit> [m]	30		
Max. height difference (H2) <Indoor unit to indoor unit> [m]	0.5		
View (Example)			

*1: For the standard pipe diameter.

Triple type

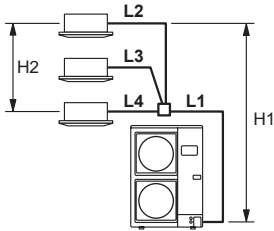
Capacity [Btu/h class]	54,000			
Indoor unit capacity [Btu/h class]	18,000 + 18,000 + 18,000			
Main pipe diameter (L1) <Liquid/Gas> (Standard) [mm (in.)]	9.52 (3/8) / 15.88 (5/8)			
Branch pipe diameter (L2, L3, L4) <Liquid/Gas> [mm (in.)]	6.35 (1/4) / 12.70 (1/2)			
Max. piping length (L1+L2+L3+L4) [m]	75 ^{*1}			
Min. piping length (L1+L2+L3+L4) [m]	5			
Max. branch piping length (L2, L3, L4) [m]	20			
Max. difference between branch lengths (L2 to L4) [m]	8			
Max. height difference (H1) <Indoor unit to outdoor unit> [m]	30			
Max. height difference (H2) <Indoor unit to indoor unit> [m]	0.5			
View (Example)				

*1: For the standard pipe diameter.

4.4. Connectable pipe diameter and max. piping length

The figures enclosed by a thick-lined frame indicate the standard pipe diameter and max. piping length.

4.4.1. Single type installation

Capacity [Btu/h class]		36,000 / 45,000 / 54,000			
Pipe diameter [mm (in.)]	Liquid pipes	9.52 (3/8)		12.70 (1/2)	
	Gas pipes	15.88 (5/8)	19.05 (3/4)	15.88 (5/8)	19.05 (3/4)
Piping length [m (m)]	Max. piping length < L1 > ^{*1} (Pre-charge length)	75 [30]	50 [30]	35 [15]	35 [15]

*1: Refer to "View" in the table of "4.3.1. Single type installation".

4.4.2. Simultaneous operation multi type installation

Twin type

Capacity [Btu/h class]		36,000			
Main piping [mm (in.)]	Liquid pipes	9.52 (3/8)		12.70 (1/2)	
	Gas pipes	15.88 (5/8)	19.05 (3/4)	15.88 (5/8)	19.05 (3/4)
Branch piping [mm (in.)]	Liquid pipes	6.35 (1/4)			
	Gas pipes	12.70 (1/2)			
Piping length [m (m)]	Max. piping length <L1+L2+L3> ^{*1} (Pre-charge length)	75 [30]	50 [30]	35 [15]	35 [15]

Capacity [Btu/h class]		45,000 / 54,000			
Main piping [mm (in.)]	Liquid pipes	9.52 (3/8)		12.70 (1/2)	
	Gas pipes	15.88 (5/8)	19.05 (3/4)	15.88 (5/8)	19.05 (3/4)
Branch piping [mm (in.)]	Liquid pipes	9.52 (3/8)			
	Gas pipes	15.88 (5/8)			
Piping length [m (m)]	Max. piping length <L1+L2+L3> ^{*1} (Pre-charge length)	75 [30]	50 [30]	35 [15]	35 [15]

*1: Refer to "View" in Twin type of 4.3.2. Simultaneous operation multi type installation.

Triple type

Capacity [Btu/h class]		54,000			
Main piping [mm (in.)]	Liquid pipes	9.52 (3/8)		12.70 (1/2)	
	Gas pipes	15.88 (5/8)	19.05 (3/4)	15.88 (5/8)	19.05 (3/4)
Branch piping [mm (in.)]	Liquid pipes	6.35 (1/4)			
	Gas pipes	12.70 (1/2)			
Piping length [m (m)]	Max. piping length <L1+L2+L3+L4> ^{*1} (Pre-charge length)	75 [30]	50 [30]	35 [15]	35 [15]

*1: Refer to "View" in Triple type of 4.3.2. Simultaneous operation multi type installation.

5. PIPE INSTALLATION-1

5.1. Opening a knock out hole

⚠ CAUTION

Be careful not to deform or scratch the panel while opening the knock out holes.

To protect the piping insulation after opening a knock out hole, remove any burrs from the edge of the hole. It is recommended to apply rust prevention paint to the edge of the hole.

- Pipes can be connected from 4 directions, front, lateral side, rear side and bottom. (Fig. A)
- When connecting at the bottom, remove the service panel and piping cover on the front of the outdoor unit, and open the knock out hole provided at the bottom corner of the piping outlet.
- It can be installed as shown on "Fig. B" cutting out the 2 slits as indicated on "Fig. C". (When cutting slits, use a steel saw.)

Fig. A

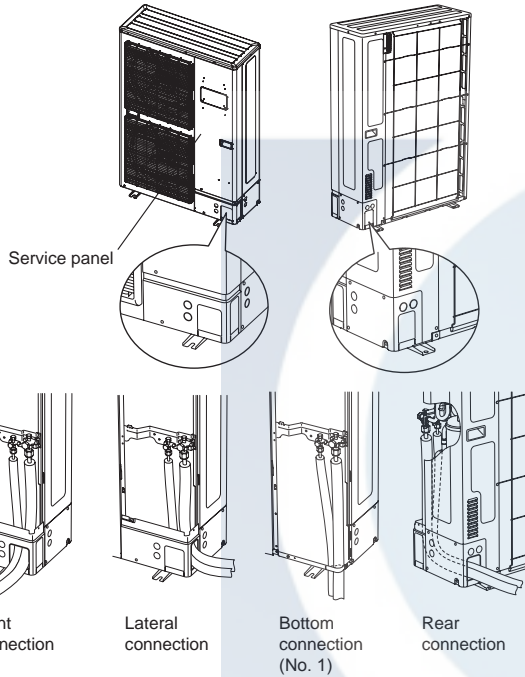

Fig. B

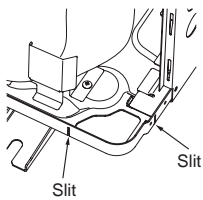
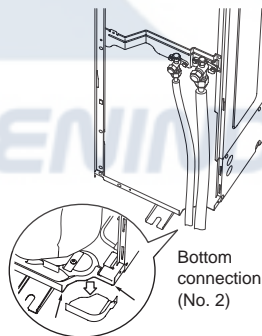

Fig. C



5.2. Brazing

⚠ CAUTION

If air or another type of refrigerant enters the refrigeration cycle, the internal pressure in the refrigeration cycle will become abnormally high and prevent the unit from exerting its full performance.

Apply nitrogen gas while brazing the pipes. If a pipe is brazed without applying nitrogen gas, an oxidation film will be created. This can degrade performance or damage the parts in the unit (such as the compressor or valves).

Nitrogen gas pressure: 0.02 MPa
(= pressure felt sufficiently on the back of the hand)

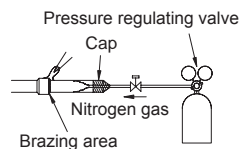

⚠ CAUTION

For brazing material, use phosphor copper that does not require flux. Do not use flux to braze pipes. If the flux is the chlorine type, it will cause the pipes to corrode. Furthermore, if the flux contains fluoride, it will adversely affect the refrigerant pipe system such as by degrading the refrigerant. If fluoride is contained, quality of refrigerant deteriorates and affects the refrigerant piping system.

5.3. Indoor unit pipe connections

5.3.1. Precautions for connecting simultaneous operation multi

⚠ CAUTION

Use genuine branch pipes for the refrigerant piping branches. Branch pipes are twin or triple type for concurrent operation, and may be used for piping between the outdoor and indoor units.

Select a twin or triple type branch pipe and purchase it before starting the installation work.

Shorten the length of branch pipes from a branch to indoor unit as short as possible. Maximum length: within 20 m.

Branch pipes shall be connected by welding (brazing).

Any vertical piping shall be in the part of the main piping. If a main pipe is bent, keep the straight part more than 10 times the diameter of the connected pipe. A variance in the amount of refrigerant may be caused if the straight part is short.

For details, refer to the Installation Manual of branch pipes.

5.3.2. Type of branch pipes

In case of a simultaneous operation multi (twin connection)

The liquid pipes and gas pipes shall be selected from the table below according to the diameter, and welded.

Small pipe diameter	
Liquid pipe 	Gas pipe
Large pipe diameter	
Liquid pipe 	Gas pipe

In case of a simultaneous operation multi (triple connection)

Weld the branch pipe shown at the left for liquid pipes, and the branch pipe shown at the right for gas pipes.

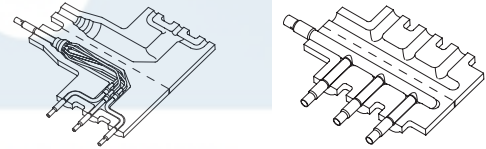

5.4. Flare connection (pipe connection)

⚠ CAUTION

Do not use mineral oil on a flared part. Prevent mineral oil from getting into the system as this would reduce the lifetime of the units.

While welding the pipes, be sure to blow dry nitrogen gas through them.

The maximum lengths of this product are shown in the table. If the units are further apart than this, correct operation cannot be guaranteed.

5.4.1. Flaring

Use special pipe cutter and flare tool exclusive for R410A.

- (1) Cut the connection pipe to the necessary length with a pipe cutter.
- (2) Hold the pipe downward so that the cuttings will not enter the pipe and remove any burrs.
- (3) Insert the flare nut (always use the flare nut attached to the indoor and outdoor units respectively) onto the pipe and perform the flare processing with a flare tool. Leakage of refrigerant may result if other flare nuts are used.
- (4) Protect the pipes by pinching them or with tape to prevent dust, dirt, or water from entering the pipes.

Check if [L] is flared uniformly and is not cracked or scratched.

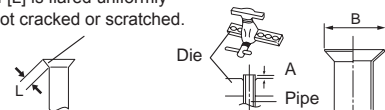

Pipe outside diameter [mm (in.)]	Dimension A [mm]
	Flare tool for R410A, clutch type
6.35 (1/4)	0 to 0.5
9.52 (3/8)	
12.70 (1/2)	
15.88 (5/8)	
19.05 (3/4)	

Pipe outside diameter [mm (in.)]	Dimension B $\begin{matrix} 0 \\ -0.4 \end{matrix}$ [mm]
	6.35 (1/4)
9.52 (3/8)	13.2
12.70 (1/2)	16.6
15.88 (5/8)	19.7
19.05 (3/4)	24.0

When using conventional flare tools to flare R410A pipes, the dimension A should be approximately 0.5 mm more than indicated in the table (for flaring with R410A flare tools) to achieve the specified flaring. Use a thickness gauge to measure the dimension A.

Width across flats



Pipe outside diameter [mm (in.)]	Width across flats of Flare nut [mm]
6.35 (1/4)	17
9.52 (3/8)	22
12.70 (1/2)	26
15.88 (5/8)	29
19.05 (3/4)	36

5.4.2. Bending pipes

CAUTION

To prevent breaking of the pipe, avoid sharp bends. Bend the pipe with a radius of curvature of 100 mm to 150 mm.

If the pipe is bent repeatedly at the same place, it will break.

- If pipes are shaped by hand, be careful not to collapse them.
- Do not bend the pipes at an angle of more than 90°.
- When pipes are repeatedly bent or stretched, the material will harden, making it difficult to bend or stretch them any more.
- Do not bend or stretch the pipes more than three times.

5.4.3. Pipe connection

CAUTION

Be sure to install the pipe against the port on the indoor unit and the outdoor unit correctly. If the centering is improper, the flare nut cannot be tightened smoothly. If the flare nut is forced to turn, the threads will be damaged.

Do not remove the flare nut from the outdoor unit pipe until immediately before connecting the connection pipe.

After installing the piping, make sure that the connection pipes do not touch the compressor or outer panel. If the pipes touch the compressor or outer panel, they will vibrate and produce noise.

- (1) Detach the caps and plugs from the pipes.
- (2) Center the pipe against the port on the outdoor unit, and then turn the flare nut by hand.
- (3) Tighten the flare nut of the connection pipe at the outdoor unit valve connector.

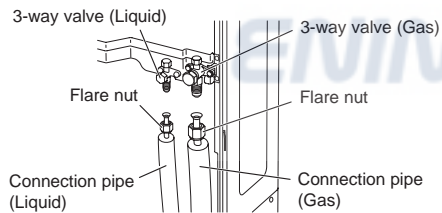

- (4) After tightening the flare nut by hand, use a torque wrench to fully tighten it.

CAUTION

Hold the torque wrench at its grip, keeping it in a right angle with the pipe, in order to tighten the flare nut correctly.

- Outer panel may be distorted if fastened only with a wrench. Be sure to fix the elementary part with a spanner and fasten with a wrench (refer to below diagram).
- Do not apply force to the blank cap of the valve or hang a wrench, etc., on the cap. It may cause leakage of refrigerant.

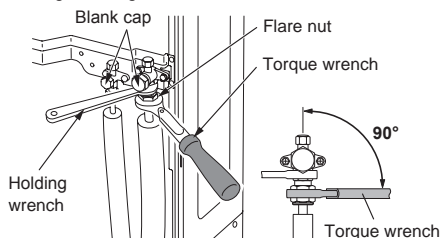

Flare nut [mm (in.)]	Tightening torque [N·m (kgf·cm)]
6.35 (1/4) dia.	16 to 18 (160 to 180)
9.52 (3/8) dia.	32 to 42 (320 to 420)
12.70 (1/2) dia.	49 to 61 (490 to 610)
15.88 (5/8) dia.	63 to 75 (630 to 750)
19.05 (3/4) dia.	90 to 110 (900 to 1100)

5.4.4. Handling precautions for the valves

- Mounted part of Blank cap is sealed for protection.
- Fasten blank cap tightly after opening valves.

Table A

Blank cap [mm (in.)]	Tightening torque [N·m (kgf·cm)]
6.35 (1/4)	20 to 25 (200 to 250)
9.52 (3/8)	20 to 25 (200 to 250)
12.70 (1/2)	25 to 30 (250 to 300)
15.88 (5/8)	30 to 35 (300 to 350)
19.05 (3/4)	35 to 40 (350 to 400)

Operating the valves

- Use a hexagon wrench (size 4 mm).
- Opening
 - (1) Insert the hexagon wrench into the valve shaft, and turn it counterclockwise.
 - (2) Stop turning when the valve shaft can no longer be turned. (Open position)
- Closing
 - (1) Insert the hexagon wrench into the valve shaft, and turn it clockwise.
 - (2) Stop turning when the valve shaft can no longer be turned. (Closed position)

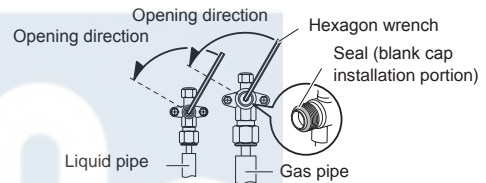

5.5. Sealing test

WARNING

Before operating the compressor, install the pipes and securely connect them. Otherwise, if the pipes are not installed and if the valves are open when the compressor operates, air could enter the refrigeration cycle. If this happens, the pressure in the refrigeration cycle will become abnormally high and cause damage or injury.

After the installation, make sure there is no refrigerant leakage. If the refrigerant leaks into the room and becomes exposed to a source of fire such as a fan heater, stove, or burner, it produces a toxic gas.

Do not subject the pipes to strong shocks during the sealing test. It can rupture the pipes and cause serious injury.

CAUTION

Do not block the walls and the ceiling until the sealing test and the charging of the refrigerant gas have been completed.

For maintenance purposes, do not bury the piping of the outdoor unit.

- After connecting the pipes, perform a sealing test.
- Make sure that the 3-way valves are closed before performing a sealing test.
- Pressurize nitrogen gas to 4.15 MPa to perform the sealing test.
- Add nitrogen gas to both the liquid pipes and the gas pipes.
- Check all flare connections and welds. Then, check that the pressure has not decreased.
- Compare the pressures after pressurizing and letting it stand for 24 hours, and check that the pressure has not decreased.
 - * When the outdoor air temperature changes 5 °C, the test pressure changes 0.05 MPa. If the pressure has dropped, the pipe joints may be leaking.
- If a leak is found, immediately repair it and perform the sealing test again.
- After completing the sealing test, release the nitrogen gas from both valves.
- Release the nitrogen gas slowly.

5.6. Vacuum process

CAUTION

Perform a refrigerant leakage test (air tightness test) to check for leaks using nitrogen gas while all valves in the outdoor unit are closed. (Use the test pressure indicated on the nameplate.)

Be sure to evacuate the refrigerant system using a vacuum pump.

The refrigerant pressure may sometimes not rise when a closed valve is opened after the system is evacuated using a vacuum pump. This is caused by the closure of the refrigerant system of the outdoor unit by the electronic expansion valve. This will not affect the operation of the unit.

If the system is not evacuated sufficiently, its performance will drop.

CAUTION

Use a clean gauge manifold and charging hose that were designed specifically for use with R410A. Using the same vacuum equipment for different refrigerants may damage the vacuum pump or the unit.

Do not purge the air with refrigerants, but use a vacuum pump to evacuate the system.

- Check that the valves are closed by removing the blank caps from the gas and liquid pipes.
- Remove the charging port cap, and connect the gauge manifold and the vacuum pump to the charging valve with the service hoses.
- Vacuum the indoor unit and the connecting pipes until the pressure gauge indicates -0.1 MPa (-76 cmHg).
- When -0.1 MPa (-76 cmHg) is reached, operate the vacuum pump for at least 60 minutes.
- Disconnect the service hoses and fit the charging port cap to the charging valve to the specified torque. (Refer to below table)
- Remove the blank caps, and fully open the 3-way valves with a hexagon wrench [Torque: 6 to 7 N·m (60 to 70 kgf·cm)].
- Tighten the blank caps of the 3-way valve to the specified torque. (Refer to Table A on page 8.)

Tightening torque [N·m (kgf·cm)]	
Charging port cap	10 to 12 (100 to 120)

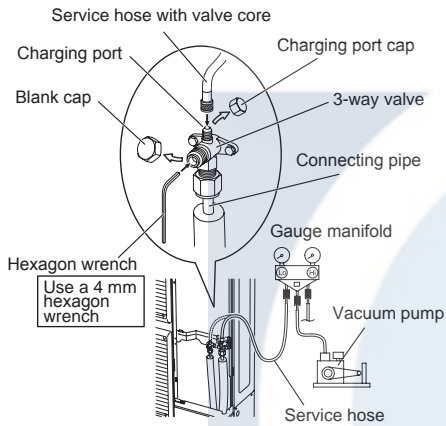

Single type

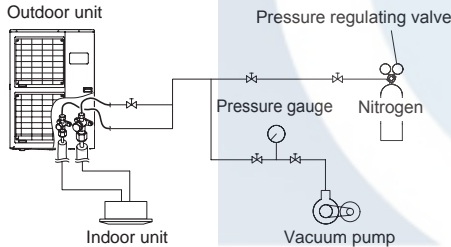

Simultaneous operation multi type

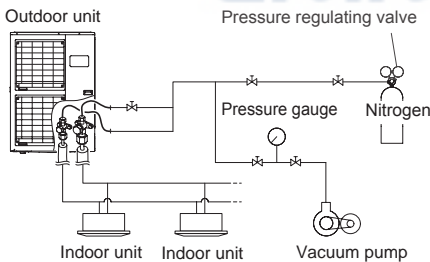

5.7. Additional charging

CAUTION

After vacuuming the system, add refrigerant.

Do not reuse recovered refrigerant.

When charging the refrigerant R410A, always use an electronic scales for refrigerant charging (to measure the refrigerant by weight). Adding more refrigerant than the specified amount will cause a malfunction.

When charging the refrigerant, take into account the slight change in the composition of the gas and liquid phases, and always charge from the liquid phase side whose composition is stable. Adding refrigerant through the gas pipe will cause a malfunction.

Check if the steel cylinder has a siphon installed or not before filling. (There is an indication "with siphon for filling liquid" on the steel cylinder.)

Filling method for cylinder with siphon

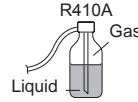

Set the cylinder vertical and fill with the liquid. (Liquid can be filled without turning bottom up with the siphon inside.)

Filling method for other cylinders

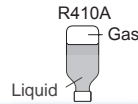

Turn bottom up and fill with liquid. (Be careful to avoid turning over the cylinder.)

Be sure to use the special tools for R410A for pressure resistance and to avoid mixing of impure substances.

If the units are further apart than the maximum pipe length, correct operation can not be guaranteed.

Make sure to back closing valve after refrigerant charging. Otherwise, the compressor may fail.

Minimize refrigerant release to the air. Excessive release is prohibited under the Freon Collection and Destruction Law.

5.7.1. For Pre-charge length

Refrigerant pipe size	Piping length (L) *Pre-Charge [m]
Standard	30
Size up (Liquid pipe)	15

5.7.2. If additional refrigerant is required

- When the piping is longer than Pre-charge length, additional charging is necessary.
- For the additional amount, see the table below.

Additional charging amount

Single type

L1 (*1) > Pre-charge length

Refrigerant pipe size [mm (in.)]	Piping length						
	~30 m	40 m	50 m	60 m	70 m	g/m	
Standard	Liquid 9.52 (3/8)	None	500 g	1,000 g	1,500 g	2,000 g	50 g/m
	Gas 15.88 (5/8)						
Size up	~30 m	40 m	50 m				g/m
	Gas 19.05 (3/4)	~15 m	25 m	35 m			g/m
	Liquid 12.70 (1/2)						
Gas 15.88 (5/8)							
Gas 19.05 (3/4)							

*1: Refer to "View" in the table of "4.3.1. Single type installation".

Simultaneous operation multi type

Twin : L1+L2+L3 (*2) > Pre-charge length

Triple : L1+L2+L3+L4 (*3) > Pre-charge length

*2 : Refer to "View" in the table of "4.3.2. Simultaneous operation multi type installation."

*3 : Refer to "View" in the table of "4.3.2. Simultaneous operation multi type installation."

The additional charging amount for twin / triple type will be calculated as follows:

Additional charging amount (g)
= (A x 100) + (B x 50) + (C x 30) - 1,500
• A = Piping length (m) of liquid pipe [12.70 mm (1/2 in.)]
• B = Piping length (m) of liquid pipe [9.52 mm (3/8 in.)]
• C = Piping length (m) of liquid pipe [6.35 mm (1/4 in.)]

Do not remove refrigerant, even if the additional amount calculated is negative.

(Example 1)

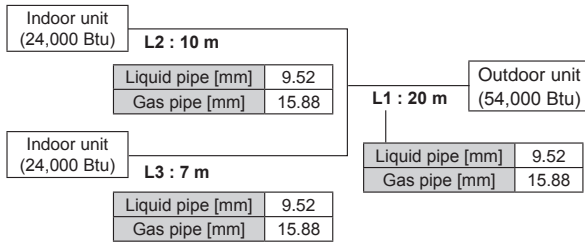

Additional charging amount

Liquid pipe diameter [mm]	Piping length [m]	Coefficient
12.70	0	A = 0
9.52	37	B = 37
6.35	0	C = 0

Applying the formula,
 $(0 \times 100) + (37 \times 50) + (0 \times 30) - 1500 = 350$
 The additional charging amount is 350 g.

(Example 2)

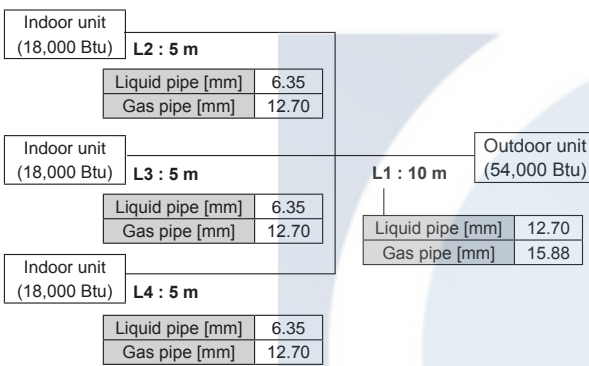

Additional charging amount

Liquid pipe diameter [mm]	Piping length [m]	Coefficient
12.70	10	A = 10
9.52	0	B = 0
6.35	15	C = 15

Applying to the formula,
 $(10 \times 100) + (0 \times 50) + (15 \times 30) - 1500 = -50$
 The calculated value is negative. Do not add or remove any refrigerant.

6. ELECTRICAL WIRING

6.1. Notes for electrical wiring

⚠ WARNING
Wiring connections must be performed by a qualified person in accordance with the specifications. The voltage rating for this product is 400 V at 50 Hz. It should be operated within the range of 342 to 456 V.
Before connecting the wires, make sure the power supply is OFF.
Use a dedicated power supply circuit. Insufficient power capacity in the electrical circuit or improper wiring may cause electric shock or fire.
Install a breaker at the power supply for each outdoor unit. Improper breaker selection can cause electric shock or fire.
Install a leakage circuit breaker in accordance with the related laws and regulations. An improperly installed electrical box cover can cause serious accidents such as electric shock or fire through exposure to dust or water.
A circuit breaker is installed in the permanent wiring. Always use a circuit that can trip all the poles of the wiring and has an isolation distance of at least 3 mm between the contacts of each pole.
Use designated cables and power cables. Improper use may cause electric shock or fire by poor connection, insufficient insulation, or over current.
Do not modify power cable, use extension cable or branch wiring. Improper use may cause electric shock or fire by poor connection, insufficient insulation or over current.
Connect the connector cable securely to the terminal. Check no mechanical force bears on the cables connected to the terminals. Faulty installation can cause a fire.
Use crimp-type terminals and tighten the terminal screws to the specified torques, otherwise, abnormal overheating may be produced and possibly cause serious damage inside the unit.

⚠ WARNING

Make sure to secure the insulation portion of the connector cable with the cable clamp. Damaged insulation can cause a short circuit.
Fix cables so that cables do not make contact with the pipes (especially on high pressure side). Do not make power supply cable and transmission cable come in contact with valves (Gas).
Never install a power factor improvement condenser. Instead of improving the power factor, the condenser may overheat.
Be sure to perform the earthing (grounding) work. Do not connect earthing (grounding) wires to a gas pipe, water pipe, lightning rod or earthing (grounding) wire for a telephone. <ul style="list-style-type: none"> • Connection to a gas pipe may cause a fire or explosion if gas leaks. • Connection to a water pipe is not an effective earthing (grounding) method if PVC pipe is used. • Connection to the earthing (grounding) wire of a telephone or to a lightning rod may cause a dangerously abnormal rise in the electrical potential if lightning strikes. Improper earthing (grounding) work can cause electric shocks.
Securely install the electrical box cover on the unit. An improperly installed service panel can cause serious accidents such as electric shock or fire through exposure to dust or water.

⚠ CAUTION

The primary power supply capacity is for the air conditioner itself, and does not include the concurrent use of other devices.
Do not start operation until the refrigerant is charged completely. The compressor will fail if it is operated before the refrigerant piping charging is complete.
Transmission cable between indoor unit and outdoor unit is 230 V.
Be sure not to remove thermistor sensor etc. from power wiring and connection wiring. Compressor may fail if operated while removed.
Start wiring work after closing branch switch and over current breaker.
Use an earth leakage breaker that is capable of handling high frequencies. Because the outdoor unit is inverter controlled, a high-frequency earth leakage breaker is necessary to prevent a malfunction of the breaker itself.
When using an earth leakage breaker that has been designed solely for earth (ground) fault protection, be sure to install a fuse-equipped switch or circuit breaker.
Do not connect the AC power supply to the transmission line terminal board. Improper wiring can damage the entire system.
Do not use crossover power supply wiring for the outdoor unit.
If the temperature surrounding the breaker is too high, the amperage at which the breaker cuts out may decrease.

How to connect wiring to the terminal

Caution when wiring cable

When stripping off the coating of a lead wire, always use a special tool such as a wire stripper. If there is no special tool available, carefully strip the coating with a knife etc.

- (1) Use crimp-type terminals with insulating sleeves as shown in the figure below to connect to the terminal block.
- (2) Securely clamp the crimp-type terminals to the wires using an appropriate tool so that the wires do not come loose.

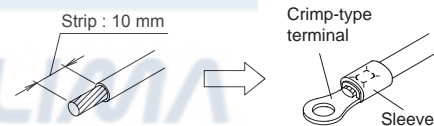

- (3) Use the specified wires, connect them securely, and fasten them so that there is no stress placed on the terminals.
- (4) Use an appropriate screwdriver to tighten the terminal screws. Do not use a screwdriver that is too small, otherwise, the screw heads may be damaged and prevent the screws from being properly tightened.
- (5) Do not tighten the terminal screws too much, otherwise, the screws may break.

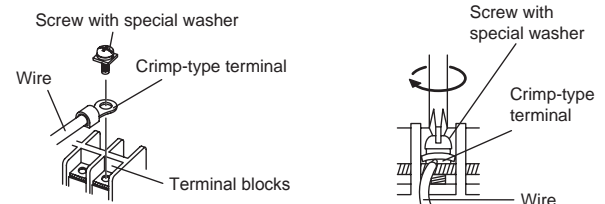

- (6) See the table below for the terminal screw tightening torques.

Tightening torque [N·m (kgf·cm)]	
M4 screw	1.2 to 1.8 (12 to 18)
M5 screw	2.0 to 3.0 (20 to 30)

6.2. Selecting circuit breaker and wiring

⚠ CAUTION

Be sure to install a breaker with specified capacity.

Before the electrical working, confirm electrical standards and regulations in each country, region, or installing place. Then select appropriate cables and breakers that comply with them.

Decide the diameter of wire referring to below table "Breaker and wiring specifications" in accordance with local and national codes.

Breaker and wiring specifications

Breaker capacity [A]	Power supply cable	Transmission cable*	
	Conductor size [mm ²]	Conductor size [mm ²]	Max. length [m]
16	2.5 (Min.)	1.5 (Min.)	75

*: If the transmission wire is longer than 50 m, use the bigger conductor size.

- Max. wire length: Set a length so that the voltage drop is less than 2%. Increase the wire diameter when the wire length is long.
- Use confirmed cable with type 60245 IEC 57.
- Install a circuit breaker with a contact gap of at least 3 mm in all poles nearby the units. (Both indoor units and outdoor units)

6.3. Knock out holes for wiring

⚠ CAUTION

Be careful not to deform or scratch the panel while opening the knock out holes.

When cables are routed from the unit, a protection sleeve for the conduits can be inserted at the knock out hole.

If you do not use a wire conduit, be sure to protect the wires to prevent the edge of the knock out hole from cutting the wires.

It is recommended to apply anti-rust paint to the edge of the knock out hole.

- Knock out holes are provided for wiring. (Fig. A)
- Knock out holes are provided 2 each in the same size in front, lateral and rear sides. (Fig. B)

Fig. A

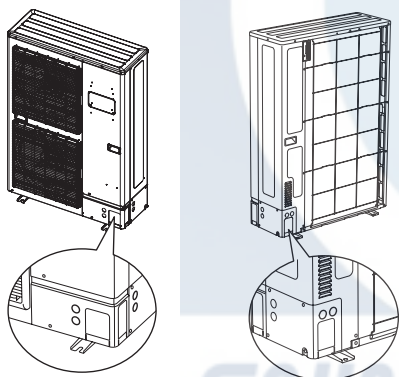
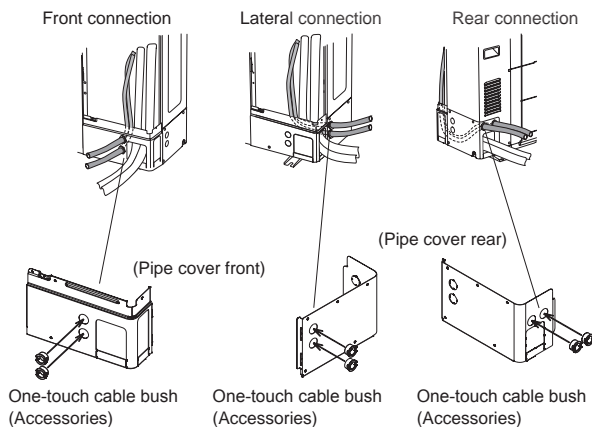

Fig. B

Installation method of One-touch bush

Please fix the One-touch bush (accessory) as shown in the figure below.



Note : Please ensure that the power cable and interconnecting cables are not installed through the same cable bush hole opening. They must be installed into the two separate hole openings to prevent damage to the cable.

6.4. Wiring method

6.4.1. Connection diagrams

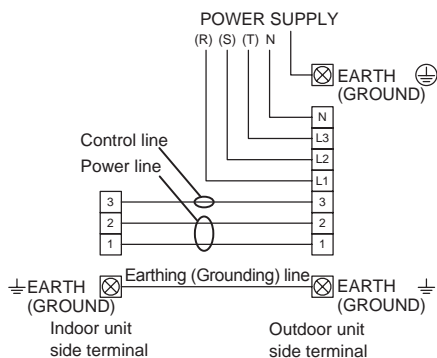

6.4.2. Connection cable preparation

Keep the earth (ground) wire longer than the other wires.

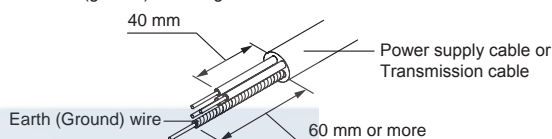

6.4.3. Wiring procedure

- (1) Remove the service panel cover, insulation sheet and connect the wires to the terminal in accordance with the terminal nameplate. (Fig. A, Fig. B)

Fig. A

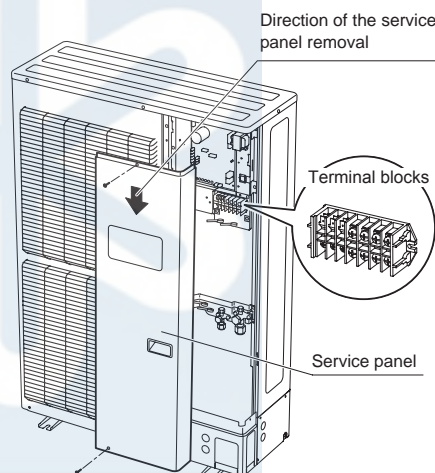

- (2) After connecting the wires, use cable clips to secure the wires. (Fig. B)

- Connect the wires without applying excessive tension.

Fig. B

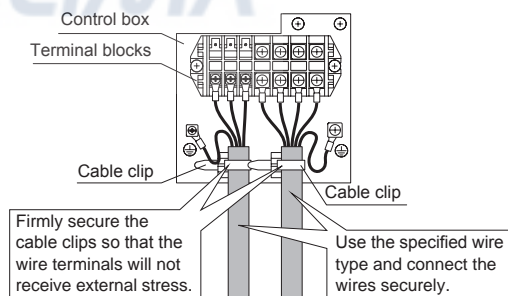

- (3) Secure the cables using the cable clips under the terminal blocks, and then secure the cables using the cable clips attached to the base of the valves.

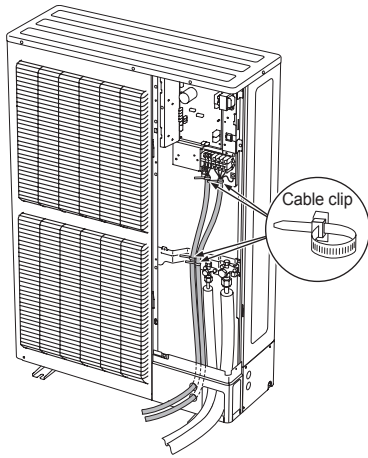

- (4) Be sure to install the insulation sheet after the wiring is complete.

7. PIPE INSTALLATION-2

⚠ WARNING

Install the insulated pipes so that they do not touch the compressor.

7.1. Installing insulation

- Use an insulation on the refrigerant pipes to prevent condensation and dripping. (Fig. A)
- Determine the thickness of the insulation material by referring to Table A.

Table A, Selection of insulation
(for using an insulation material with equal heat transmission rate or below 0.040 W/(m·k))

Relative humidity [mm (in.)]		Insulation material Minimum thickness [mm]			
		70% or more	75% or more	80% or more	85% or more
Pipe diameter	6.35 (1/4)	8	10	13	17
	9.52 (3/8)	9	11	14	18
	12.70 (1/2)	10	12	15	19
	15.88 (5/8)	10	12	16	20
	19.05 (3/4)	10	13	16	21

If the ambient temperature and relative humidity exceed 32 °C, increase the level of heat insulation for the refrigerant pipes.

7.2. Filling with putty

⚠ WARNING

Fill the piping holes with putty (supplied locally) to avoid any gap (Fig A). If small animals such as insects enter the external unit, a short circuit may be caused near electrical components in the service panel.

If the outdoor unit is installed at a level that is higher than the indoor unit, the water that has condensed in the 3-way valve of the outdoor unit could travel to the indoor unit. Therefore, use putty in the space between the pipe and the insulation to prevent the entry of water.

Fig. A

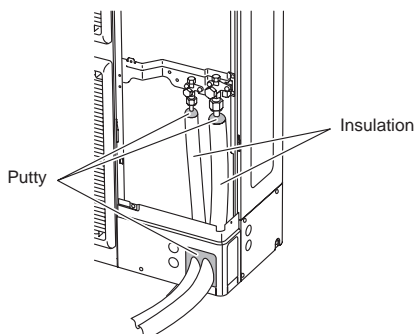

8. HOW TO OPERATE DISPLAY UNIT

8.1. Various setting methods

⚠ WARNING

Never touch electrical components such as the terminal blocks or reactor except the switch on the display board. It may cause a serious accident such as electric shock.

⚠ CAUTION

Once refrigerant charging is completed, be sure to open the valve prior to performing the local settings. Otherwise, the compressor may fail.

Discharge any static electricity from your body before touching the push switches. Never touch any terminal or pattern of any parts on the control board.

- The positions of the switches on the outdoor unit control board are shown in the figure below.

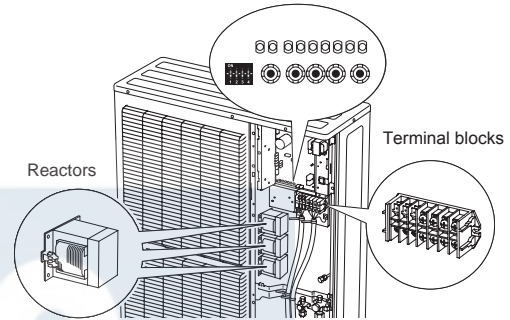

- Various settings can be adjusted by changing DIP switches and push switches on the board of the outdoor unit.

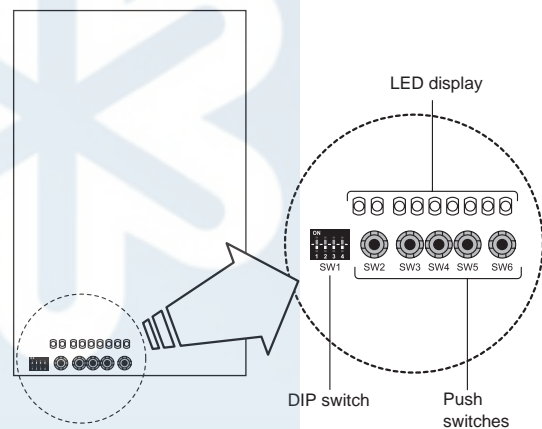

- The printed characters for the LED display are shown below.

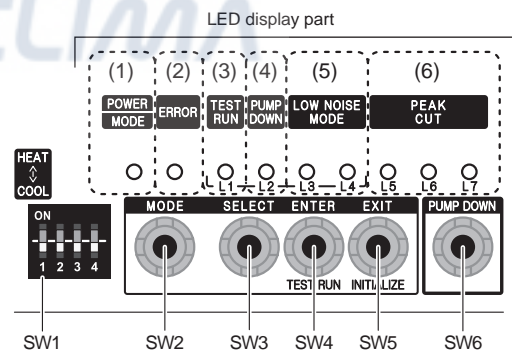

8.2. Description of display

Display lamp	Function or operation method
(1) POWER/MODE	Green Lights on while power on Local setting in outdoor unit or error code is displayed with blink.
(2) ERROR	Red Blinks during abnormal air-conditioner operation.
(3) TEST RUN (L1)	Orange Lights on during test operation.
(4) PUMP DOWN (L2)	Orange Lights on during pump down operation.
(5) LOW NOISE MODE (L3, L4)	Orange Lights on during "Low noise" function when local setting is activated. (Lighting pattern of L3 and L4 indicates low noise level) ⇒ Refer to "9. LOCAL SETTING".
(6) PEAK CUT (L5, L6, L7)	Orange Lights on during "Peak cut" function when local setting is activated. (Lighting pattern of L5, L6 and L7 indicates peak cut level) ⇒ Refer to "9. LOCAL SETTING".

Switch	Function or operation method
SW1	DIP switch For selecting cooling or heating during test operation. Positions 2 to 4 of DIP switch are not used.
SW2	Push switch To switch between "Local setting" and "Error code display".
SW3	Push switch To switch between the individual "Local settings" and the "Error code displays".
SW4	Push switch To fix the individual "Local settings", "Test run" and the "Error code displays".
SW5	Push switch EXIT
SW6	Push switch To start the pump down operation.

• DIP switches 1 to 4 at shipment from the factory are set as follows.

DIP switch			
1	2	3	4
COOL	OFF	OFF	OFF

9. LOCAL SETTING

CAUTION

Discharge the static electricity from your body before setting up the switches.
Never touch the terminals or the patterns on the parts that are mounted on the board.

9.1. Low noise mode (Local work)

Outdoor unit may be operated with lower noise than normal operation when following below local work.

- Low noise operation is available by installation of an additional commercially available timer or contact input from the ON-OFF switch to the CN19 connector (an external contact input sold separately) on the control board of the outdoor unit.

* Performance may be deficient depending on outdoor temperature or conditions etc.

< Example of circuit diagram >

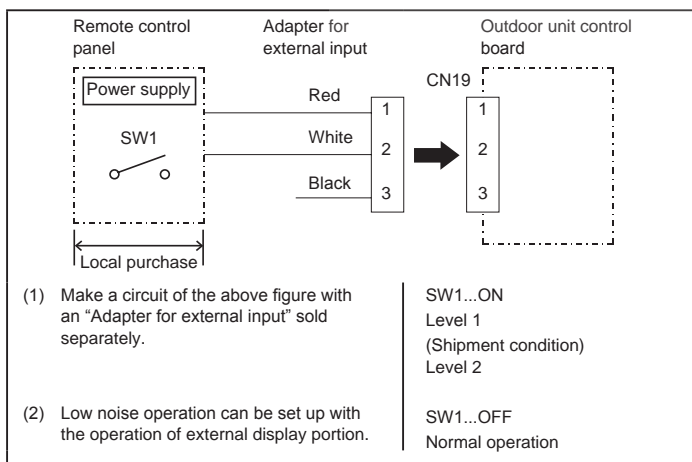

9.1.1. Setting for low noise

LED display part

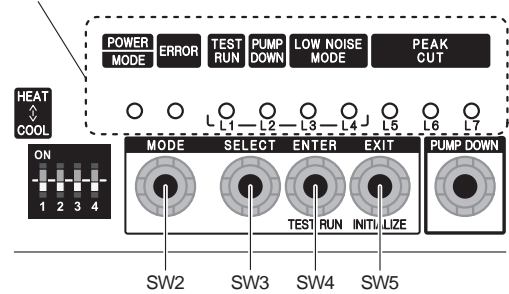

- (1) Switch to "Local setting mode" by pressing **MODE** switch (SW2) for 3 seconds or more.
- (2) Confirm POWER/MODE LED blinks 9 times, and press **ENTER** switch (SW4).

POWER/MODE	ERROR	TEST RUN (L1)	PUMP DOWN (L2)	LOW NOISE (L3) (L4)	PEAK CUT (L5) (L6) (L7)
Blinks (9 times)	○	○	○	○	○

Sign "○": Lights off

- (3) Press **SELECT** switch (SW3), and adjust LED display as shown below. (Current setting is displayed)

LOW NOISE MODE	TEST RUN (L1)	PUMP DOWN (L2)	LOW NOISE (L3) (L4)
	○	○	○

- (4) Press **ENTER** switch (SW4).

LOW NOISE MODE	TEST RUN (L1)	PUMP DOWN (L2)	LOW NOISE (L3) (L4)
	○	○	○

Sign "●": Lights on

- (5) Press **SELECT** switch (SW3), and adjust LED display as shown in below figure.

	PEAK CUT		
	(L5)	(L6)	(L7)
	Level 1	○	○
Level 2	○	Blink	○

- (6) Press **ENTER** switch (SW4) and fix it.

	PEAK CUT		
	(L5)	(L6)	(L7)
	Level 1	○	○
Level 2	○	●	○

- (7) Return to "Operating status display (Normal operation)" by pressing **EXIT** switch (SW5).

In case of missing how many times **SELECT** and **ENTER** switch are pressed, restart from the beginning of operation procedure after returning to "Operation status display (normal operation)" by pressing the **EXIT** switch once.

9.2. Peak cut mode (Local work)

Efficient operation while reducing power supply and power consumption with below local work.

- Peak cut function can be effective with contact installation of an additional ON-OFF switch to the CN19 connector on the outdoor control board.

< Example of circuit diagram >

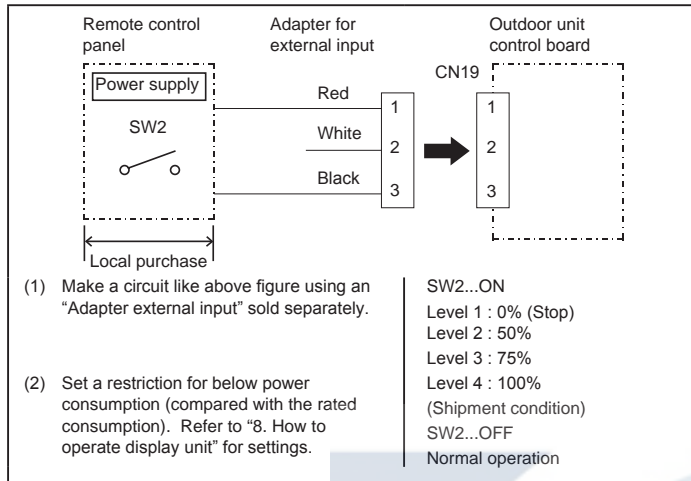

9.2.1. Setting for peak cut

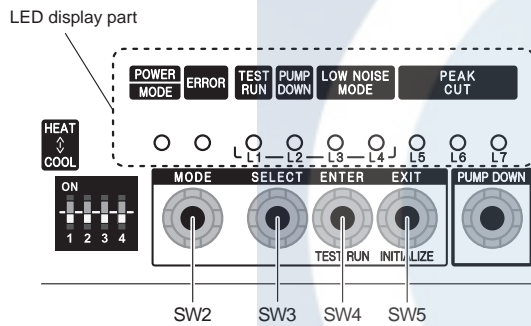

- Switch to "Local setting mode" by pressing **MODE** switch (SW2) for 3 seconds or more.
- Confirm **POWER/MODE** LED blinks 9 times, and press **ENTER** switch (SW4).

POWER MODE	ERROR	TEST RUN (L1)	PUMP DOWN (L2)	LOW NOISE (L3) (L4)	PEAK CUT (L5) (L6) (L7)
Blinks (9 times)	○	○	○	○	○

Sign "○": Lights off

- Press **SELECT** switch (SW3), and adjust LED display as shown below. (Current setting is displayed)

PEAK CUT MODE	TEST RUN (L1)	PUMP DOWN (L2)	LOW NOISE (L3) (L4)
	○	○	Blink

- Press **ENTER** switch (SW4).

PEAK CUT MODE	TEST RUN (L1)	PUMP DOWN (L2)	LOW NOISE (L3) (L4)
	○	○	●

Sign "●": Lights on

- Press **SELECT** switch (SW3), and adjust LED display as shown in below figure.

	PEAK CUT		
	(L5)	(L6)	(L7)
	0% of rated input ratio	○	○
	50% of rated input ratio	○	Blink
75% of rated input ratio	○	Blink	
100% of rated input ratio	Blink	○	

- Press **ENTER** switch (SW4) and fix it.

	PEAK CUT		
	(L5)	(L6)	(L7)
	0% of rated input ratio	○	○
	50% of rated input ratio	○	●
75% of rated input ratio	○	●	
100% of rated input ratio	●	○	

- Return to "Operating status display (Normal operation)" by pressing **EXIT** switch (SW5).

When pressed number is lost during operation, restart from the beginning of operation procedure after returning to "Operation status display (normal operation)" by pressing the **EXIT** switch once.

10. TEST RUN

CAUTION

Always turn on the power 6 hours prior to the start of the operation in order to protect the compressor.

10.1. Check items before performing the test run

- Make sure to perform the test run.
- Before performing the test run, be sure to check the following points.
 - Is gas leaking?
 - Check connection of each pipe (flare connection part, brazing part).
 - Is a breaker installed to the power cable of the outdoor unit?
 - Has each cable been securely connected to the terminal according to the specifications?
 - Are the 3-way valves (gas pipes and liquid pipes) of the outdoor units open?
 - Has the power been supplied to the unit for at least 6 hours?
 - Has the necessary local setting been done?
 - Check insulation resistance of 1 MΩ or more using a 500 V mega tester.
- If no problems are found with the above items, perform the test run according to "Test run method".
- If any problems are found, immediately resolve the problem and re-check the items.

10.2. Test run method

CAUTION

If the test run is performed for 1 outdoor unit in a group control system installation, the test run will also be performed for the other units. Therefore, make sure that all of the units have been installed before starting a test run. (Group control system installation described in "SPECIAL INSTALLATION METHODS" in the installation manual of the indoor unit.)

- Operate **ENTER** (TEST RUN) switch on the display board by the following procedure.

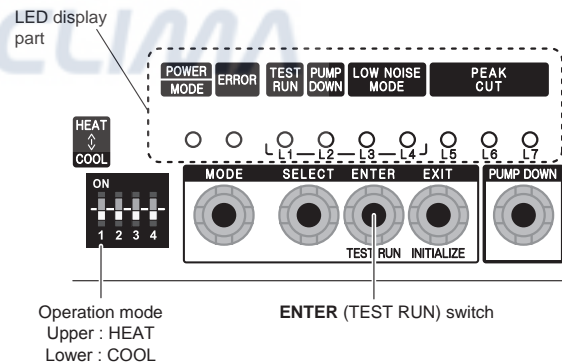

10.2.1. Operating procedures for the test run

- Check the 3-way valves (both at the liquid side and gas side) are opened.
- Set the operation mode to "COOL" or "HEAT".

POWER MODE	ERROR	TEST RUN (L1)	PUMP DOWN (L2)	LOW NOISE (L3) (L4)	PEAK CUT (L5) (L6) (L7)
●	○	○	○	○	○

- In the first test run, be sure to set the operation mode to "COOL".
- The operation mode cannot be switched between "COOL" and "HEAT" during the test run. To switch the operation mode between "COOL" and "HEAT", stop the test run, switch the operation mode, and then start the test run again.

(3) Press **ENTER** (TEST RUN) switch for more than 3 seconds.

POWER	ERROR	TEST RUN (L1)	PUMP DOWN (L2)	LOW NOISE (L3) (L4)		PEAK CUT (L5) (L6) (L7)		
MODE								
●	○	●	○	○	○	○	○	○

TEST RUN LED will light on.

- If the compressor is operating at starting the test run, the compressor will stop and, after a while, the test run will start.
- Either of the above LOW NOISE or PEAK CUT LED will light on during the test run if local setting function is selected.

(4) Confirm operating status.

(5) Press **ENTER** (TEST RUN) switch again.

POWER	ERROR	TEST RUN (L1)	PUMP DOWN (L2)	LOW NOISE (L3) (L4)		PEAK CUT (L5) (L6) (L7)		
MODE								
●	○	○	○	○	○	○	○	○

TEST RUN LED lights off, and TEST RUN stops.

- Test run will finish after about 60 minutes automatically. At the same time, TEST RUN LED will light off.
- Test run may be stopped before operating for 60 minutes if an error occurs after a starting test run.

11. PUMP DOWN

⚠ WARNING

Never touch electrical components such as the terminal blocks or reactor except the switch on the display board. It may cause a serious accident such as electric shock.

⚠ CAUTION

Perform the pump down operation before disconnecting any refrigerant pipe or electric cable.

Collect refrigerant from the service port or the 3-way valve if pump down cannot be performed.

In case of a group control system installation, do not turn the power off pump down is completed in all outdoor units.
(Group control system installation described in "SPECIAL INSTALLATION METHODS" in the installation manual of the indoor unit.)

Operate **PUMP DOWN** switch on the display board in the manner described below.

LED display part

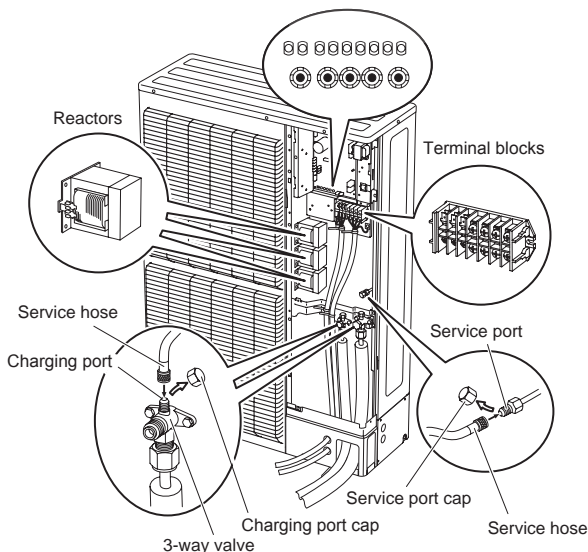
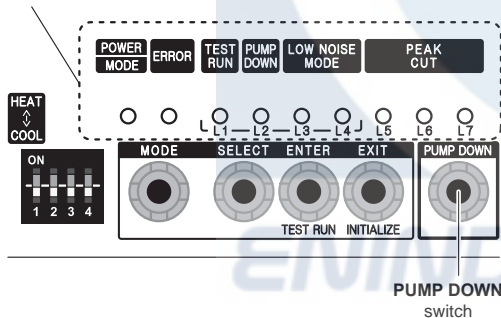

11.1. Preparation for pump down

Confirm that the power is off, and then open the service panel.

11.2. Pump down procedure

- (1) Check the 3-way valves (both at the liquid side and gas side) are opened.
- (2) Turn the power on.

POWER	ERROR	TEST RUN (L1)	PUMP DOWN (L2)	LOW NOISE (L3) (L4)		PEAK CUT (L5) (L6) (L7)		
MODE								
●	○	○	○	○	○	○	○	○

- (3) Press **PUMP DOWN** switch for 3 seconds or more after 3 minutes after power on.

POWER	ERROR	TEST RUN (L1)	PUMP DOWN (L2)	LOW NOISE (L3) (L4)		PEAK CUT (L5) (L6) (L7)		
MODE								
●	○	○	●	○	○	●	●	●

LED display lights on as shown in the above figure, and the fans and the compressor start operating.

- (4) LED display will change as shown below about 3 minutes after the compressor starts. Fully close the 3-way valve on the liquid pipe side at this stage.

POWER	ERROR	TEST RUN (L1)	PUMP DOWN (L2)	LOW NOISE (L3) (L4)		PEAK CUT (L5) (L6) (L7)		
MODE								
●	○	○	●	○	○	○	●	●

- If the valve on the liquid pipe side is not closed, the pump down cannot be performed.

- (5) When LED display changes as shown in the below figure, close the 3-way valve on the gas pipe side tightly.

POWER	ERROR	TEST RUN (L1)	PUMP DOWN (L2)	LOW NOISE (L3) (L4)		PEAK CUT (L5) (L6) (L7)		
MODE								
●	○	○	●	○	○	○	○	●

If the valve on the gas pipe side is not closed, refrigerant may flow into the piping after the compressor stops.

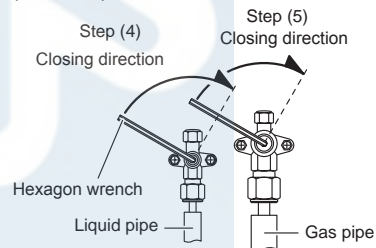

- (6) LED display changes after 1 minute as shown in the figure below.

POWER	ERROR	TEST RUN (L1)	PUMP DOWN (L2)	LOW NOISE (L3) (L4)		PEAK CUT (L5) (L6) (L7)		
MODE								
●	○	○	●	○	○	○	○	○

Fans and compressor stop automatically.

If the pump down is successfully completed (the above LED display is shown), the outdoor unit remains stopped until the power is turned off.

- (7) Turn the power off.

POWER	ERROR	TEST RUN (L1)	PUMP DOWN (L2)	LOW NOISE (L3) (L4)		PEAK CUT (L5) (L6) (L7)		
MODE								
○	○	○	○	○	○	○	○	○

PUMP DOWN is completed.

Notes:

- To stop pump down, press the **PUMP DOWN** switch again.
- To start the pump down again after the compressor is automatically stopped due to an error, turn the power off and open the 3-way valves. Wait 3 minutes, turn the power on and start the pump down again.
- When starting the operation after completion of the pump down, turn the power off, and then open the 3-way valves. Wait 3 minutes, turn the power on and perform a test run in the "COOL" operation mode.

12. ERROR CODE DISPLAY

When an error occurs, "short-press" the **ENTER** switch once. The number of blinks of the LED indicates the type of error.

12.1. How to check error code

12.1.1. Display when an error occurs

POWER MODE	ERROR	TEST RUN (L1)	PUMP DOWN (L2)	LOW NOISE (L3) (L4)		PEAK CUT (L5) (L6) (L7)		
●	Blinks (Hi-speed)	○	○	○	○	○	○	○

Check that the ERROR LED blinks, and then short-press the **ENTER** switch once.

12.2. Error code check table

POWER MODE	ERROR	TEST RUN (L1)	PUMP DOWN (L2)	LOW NOISE (L3) (L4)		PEAK CUT (L5) (L6) (L7)			Description
◆(2)	●	◆(1)	◆(1)	○	○	○	●	●	Serial forward transmission error immediately after operation
◆(2)	●	◆(1)	◆(1)	○	○	●	○	○	Serial forward transmission error during operation
◆(2)	●	◆(2)	◆(2)	○	○	○	○	●	Indoor unit capacity error
◆(2)	●	◆(5)	◆(15)	○	○	○	○	●	Indoor unit error
◆(2)	●	◆(6)	◆(1)	○	○	○	○	●	Over voltage
◆(2)	●	◆(6)	◆(1)	○	○	○	●	●	Power supply frequency error
◆(2)	●	◆(6)	◆(2)	○	○	○	○	●	Outdoor unit PCB model information error
◆(2)	●	◆(6)	◆(2)	○	○	●	●	●	PFC communication error
◆(2)	●	◆(6)	◆(3)	○	○	○	○	●	Inverter error
◆(2)	●	◆(6)	◆(4)	○	○	●	●	●	PFC AD detection error
◆(2)	●	◆(6)	◆(4)	○	●	○	○	○	PFC hardware error
◆(2)	●	◆(6)	◆(5)	○	○	○	●	●	IPM error (Trip terminal L error)
◆(2)	●	◆(6)	◆(8)	○	○	○	●	○	Rush current limiting resistor temp rise protection
◆(2)	●	◆(7)	◆(1)	○	○	○	○	●	Discharge temp. sensor error
◆(2)	●	◆(7)	◆(2)	○	○	○	○	●	Compressor temp. sensor error
◆(2)	●	◆(7)	◆(3)	○	○	○	●	○	Heat Ex. middle temp. sensor error
◆(2)	●	◆(7)	◆(3)	○	○	○	●	●	Outdoor unit Heat Ex. liquid temp. sensor error
◆(2)	●	◆(7)	◆(4)	○	○	○	○	●	Outdoor temp. sensor error
◆(2)	●	◆(7)	◆(7)	○	○	○	○	●	Heat sink temp. sensor error
◆(2)	●	◆(7)	◆(7)	○	○	○	●	○	PFC heat sink temp. sensor error
◆(2)	●	◆(8)	◆(4)	○	○	○	○	●	Current sensor 1 error (stoppage permanently)
◆(2)	●	◆(8)	◆(6)	○	○	●	○	○	High pressure switch 1 error
◆(2)	●	◆(8)	◆(6)	○	○	●	●	○	Pressure sensor error
◆(2)	●	◆(9)	◆(4)	○	○	○	○	●	Trip detection (stoppage permanently)
◆(2)	●	◆(9)	◆(5)	○	○	○	○	●	Compressor motor control error (stoppage permanently)
◆(2)	●	◆(9)	◆(5)	○	○	●	○	●	Compressor motor loss of synchronization (stoppage permanently)
◆(2)	●	◆(9)	◆(7)	○	○	○	●	●	Outdoor unit fan motor 1 error (Duty error)
◆(2)	●	◆(9)	◆(8)	○	○	○	●	●	Outdoor unit fan motor 2 error (Duty error)
◆(2)	●	◆(9)	◆(9)	○	○	○	○	●	4-way valve error
◆(2)	●	◆(10)	◆(1)	○	○	○	○	●	Discharge temp. 1 error (stoppage permanently)
◆(2)	●	◆(10)	◆(3)	○	○	○	○	●	Compressor 1 temp. error (stoppage permanently)
◆(2)	●	◆(10)	◆(5)	○	○	○	○	●	Low pressure error

Display mode ● : Lights on
 ○ : Lights off
 ◆ : Blink (0.5s Lights on / 0.5s Lights off)
 () : Number of flashing

