

**SPLIT TYPE
AIR CONDITIONER**

CEILING type (50Hz)

SERVICE MANUAL



Models

Indoor unit

Outdoor unit

ABYA36LAT

AOYA36LATL

ABYA45LAT

AOYA45LATL



ENINDEL CLIMA

CONTENTS

SPECIFICATIONS.....	1
DIMENSIONS	2
REFRIGERANT SYSTEM DIAGRAM.....	4
CIRCUIT DIAGRAM	5
INDOOR PCB CIRCUIT DIAGRAM	7
OUTDOOR PCB CIRCUIT DIAGRAM.....	11
ERROR CONTENTS	14
PARTS (INDOOR UNIT).....	16
PARTS (OUTDOOR UNIT).....	21
STANDARD ACCESSORIES.....	25

SPECIFICATIONS

ELECTRICAL DATA

TYPE		Cooling & Heating	
INDOOR UNIT		ABYA36LAT	ABYA45LAT
OUTDOOR UNIT		AOYA36LATL	AOYA45LATL
COOLING CAPACITY		10.0 kW	12.5 kW
HEATING CAPACITY		11.2 kW	14.0 kW
POWER SOURCE		230 V 50 Hz	230 V 50 Hz
RUNNING CURRENT	Cooling	13.6 A	17.0 A
	Heating	13.2 A	16.5 A
INPUT WATTS	Cooling	3.11 kW	3.89 kW
	Heating	3.02 kW	3.77 kW
E.E.R.	Cooling	3.21 kW/kW	3.21 kW/kW
	Heating	3.71 kW/kW	3.71 kW/kW
MOISTURE REMOVAL		3.0 L/hr	4.5 L/hr
AIRCIRCULATION INDOOR		2,020 m3/hr	2,250 m3/hr
AIRCIRCULATION OUTDOOR		6,600 m3/hr	6,600 m3/hr
MAXIMUM CURRENT		. A	. A

FAN MOTOR

INDOOR UNIT	Discrimination	MFH-45RV	MFH-45RV
	High speed	1,100 r.p.m.	1,200 r.p.m.
	Med speed	910 r.p.m.	1,000 r.p.m.
	Low speed	750 r.p.m.	830 r.p.m.
	Quiet	650 r.p.m.	680 r.p.m.
OUTDOOR UNIT	Discrimination	MFE-60PO	MFE-60PO
	Upper fan	850 r.p.m.	850 r.p.m.
	Lower fan	750 r.p.m.	750 r.p.m.

NOISE LEVEL

INDOOR UNIT	High speed	47 dB	49 dB
	Med speed	43 dB	45 dB
	Low speed	37 dB	39 dB
	Quiet	32 dB	34 dB
OUTDOOR UNIT	Cooling	54 dB	55 dB
	Heating	55 dB	56 dB

Note : Static pressure : 30Pa

Duct length : Inlet 1m, Outlet 2m

DIMENSIONS

INDOOR UNIT	H x W x D	240 x 1,660 x 700 mm
OUTDOOR UNIT	H x W x D	1,290 x 900 x 330 mm

WEIGHT

INDOOR UNIT	Gross / Net	58 kg / 44 kg
OUTDOOR UNIT	Gross / Net	107 kg / 98 kg

COMPRESSOR AND REFRIGERANT

TYPE	Hermetic type, Inverter, 4 poles, 3 phase, DC motor, Twin Rotary	
DISCRIMINATION	DA420A3F-21ZA	
WEIGHT (with oil)	. kg	
STANDARD REFRIGERANT	3,350 g	
REFRIGERANT TYPE	R410A	
MAX PIPE LENGTH	50 m	
MAX PIPE HEIGHT	30 m	
FULL CHARGE	Pipe length 20 m	3,350 g
	30 m	3,850 g
	40 m	4,350 g
	50 m	4,850 g
ADDITIONAL CHARGE	50 g/m	

DIMENSIONS

INDOOR UNIT

(Unit : mm)

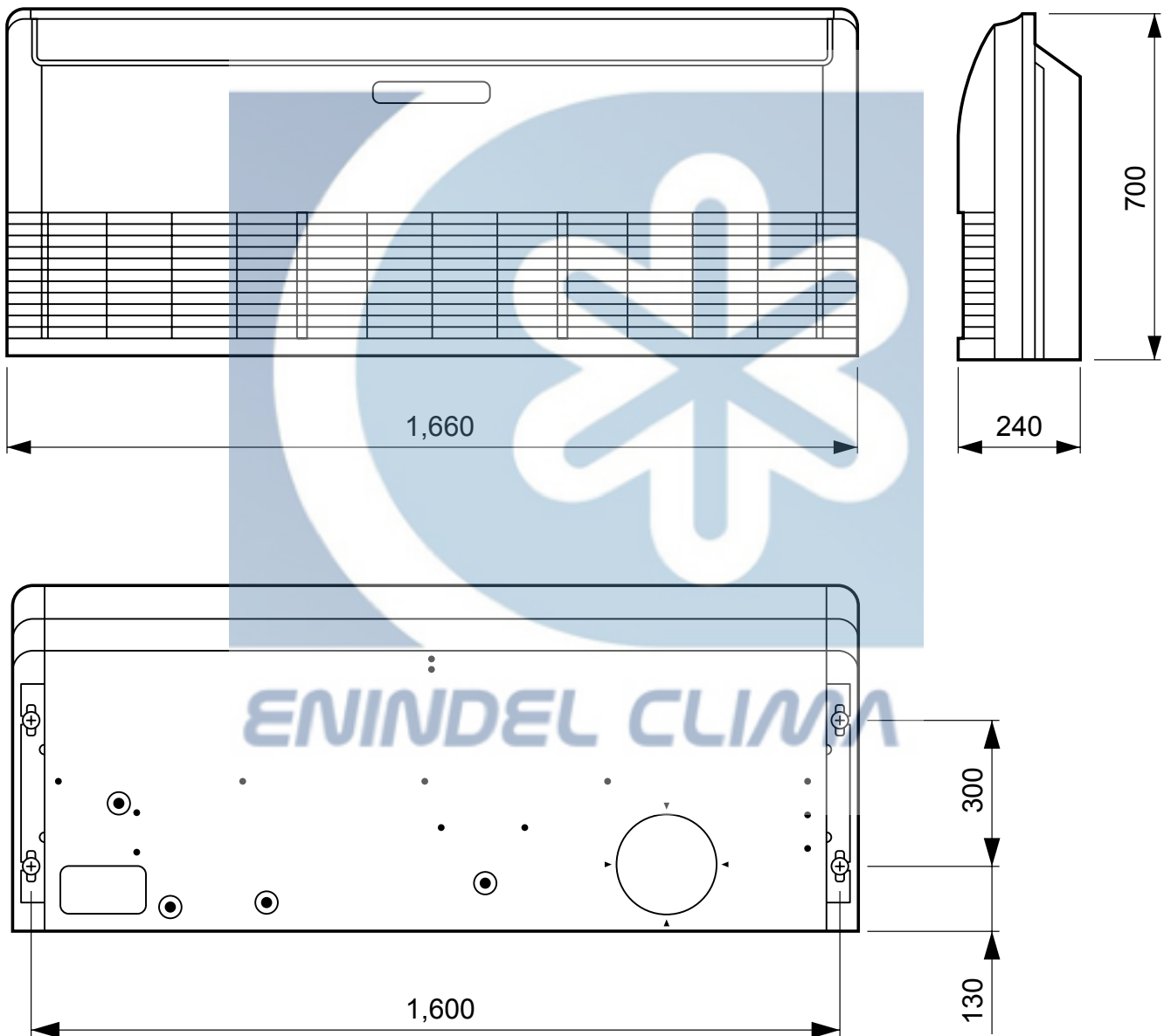

OUTDOOR UNIT

(Unit : mm)

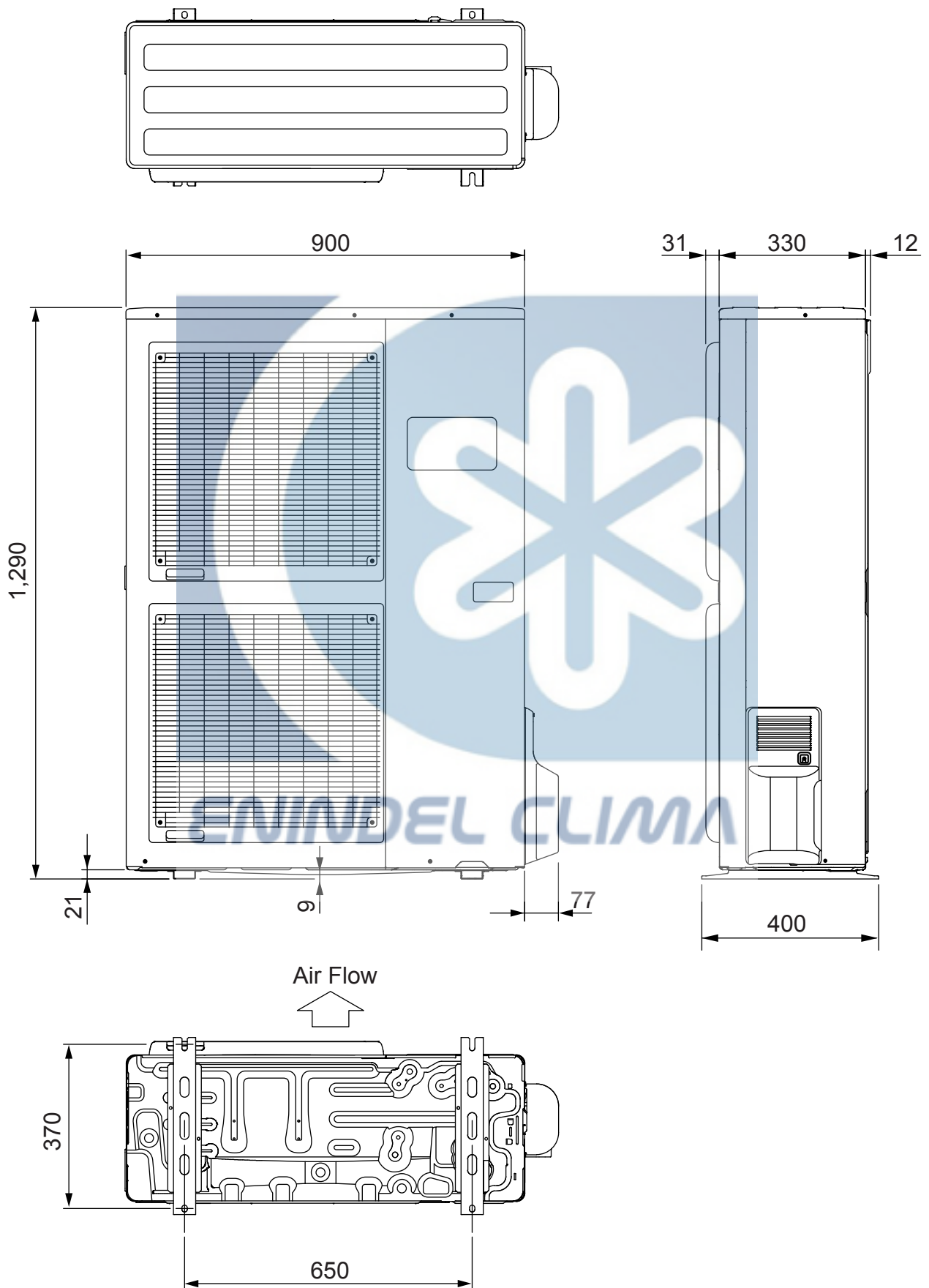

REFRIGERANT SYSTEM DIAGRAM

Refrigerant direction
 ———> : Cool
 - - - -> : Heat

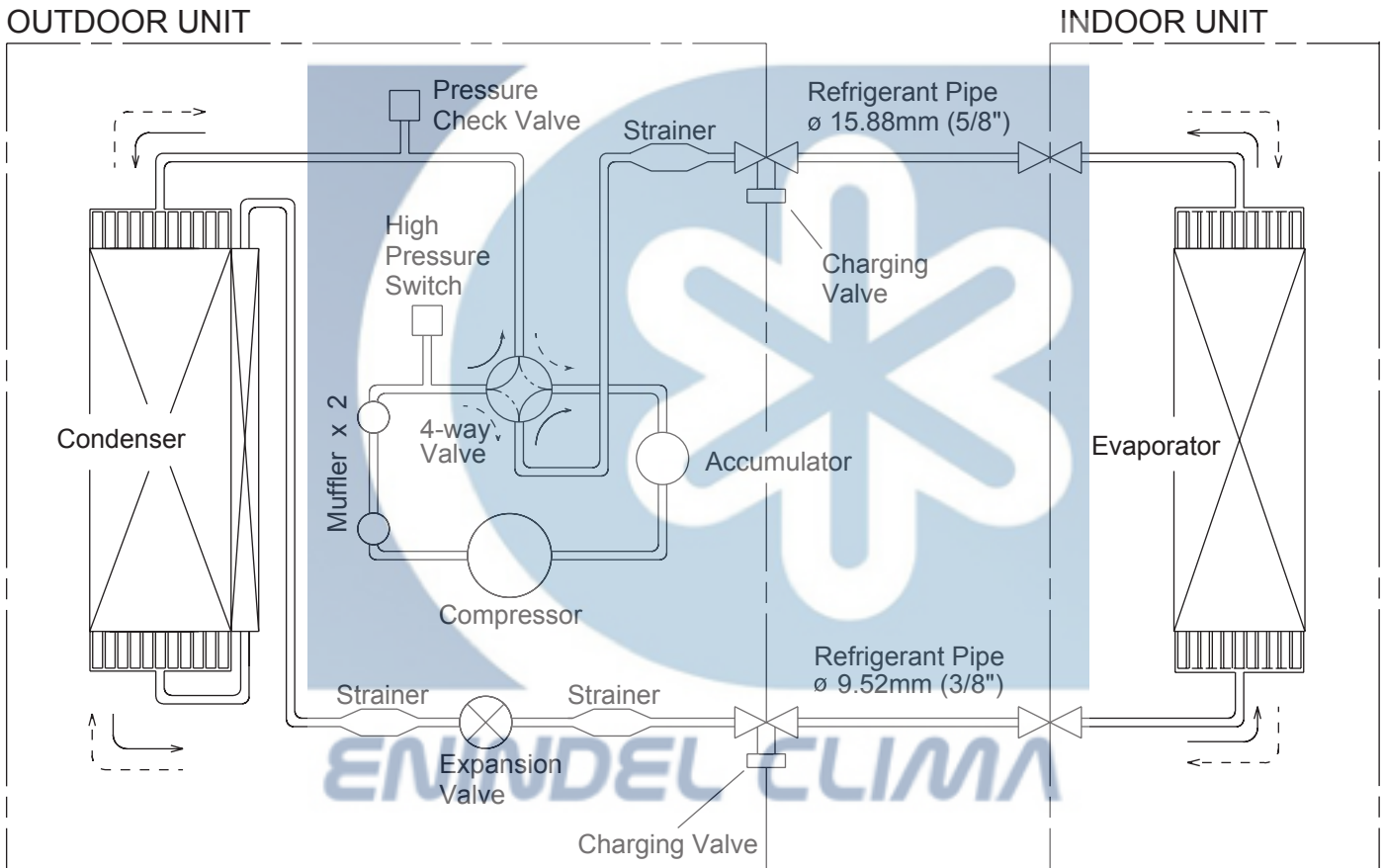

CIRCUIT DIAGRAM

INDOOR UNIT

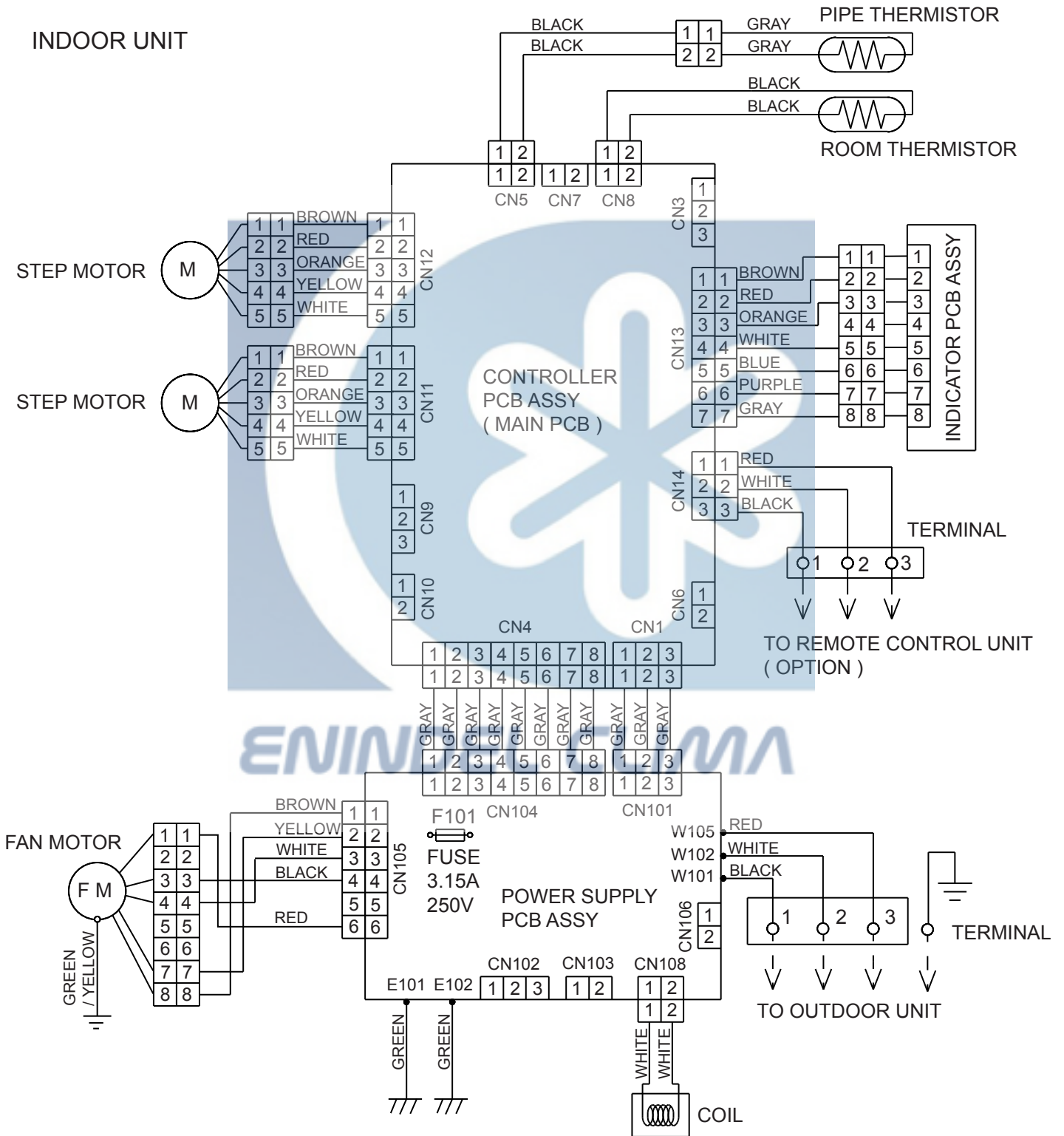

OUTDOOR UNIT

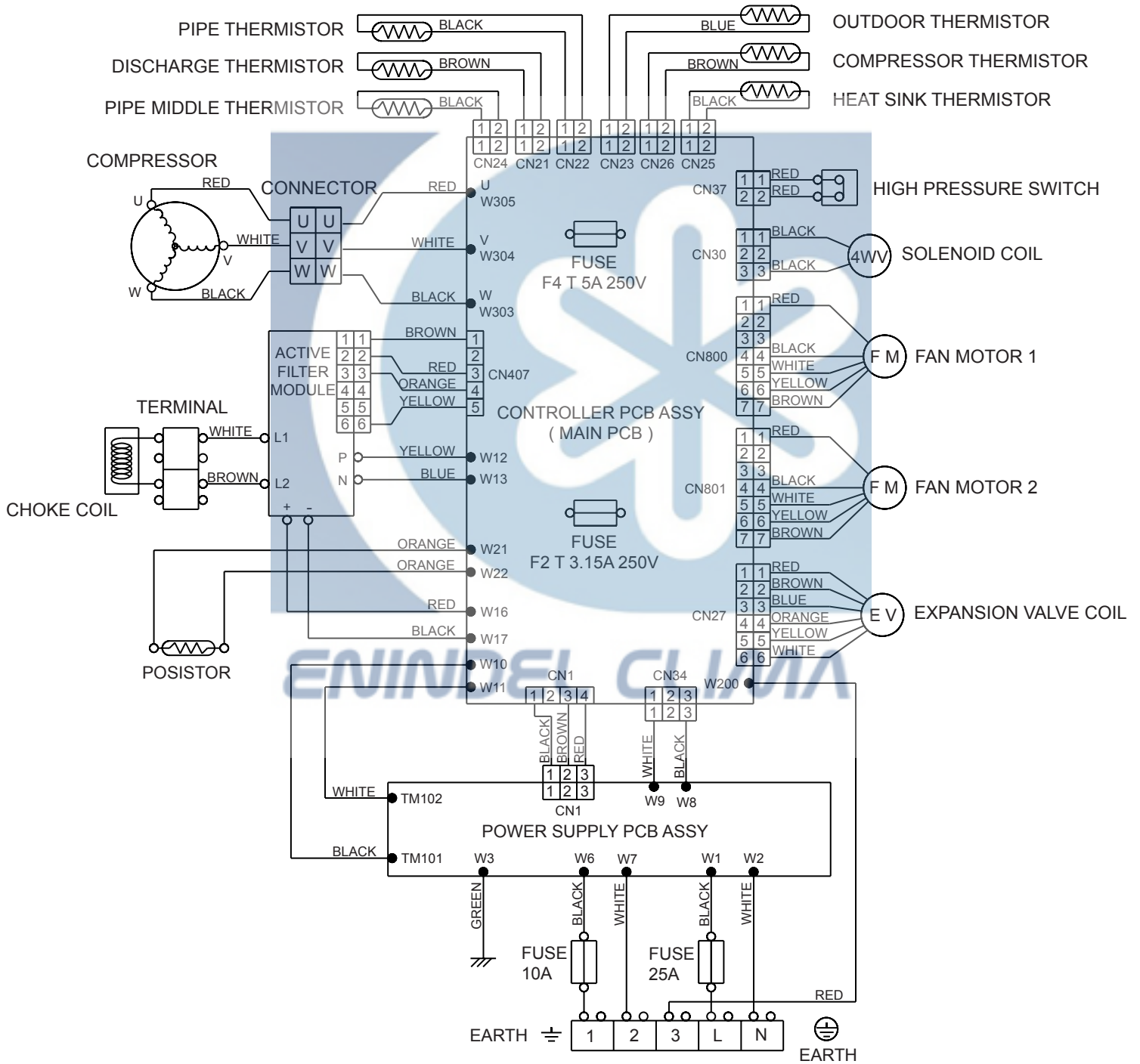

INDOOR PCB CIRCUIT DIAGRAM

CONTROL UNIT

ABYA36LAT : EZ-0061EHSE

ABYA45LAT : EZ-0061DHSE

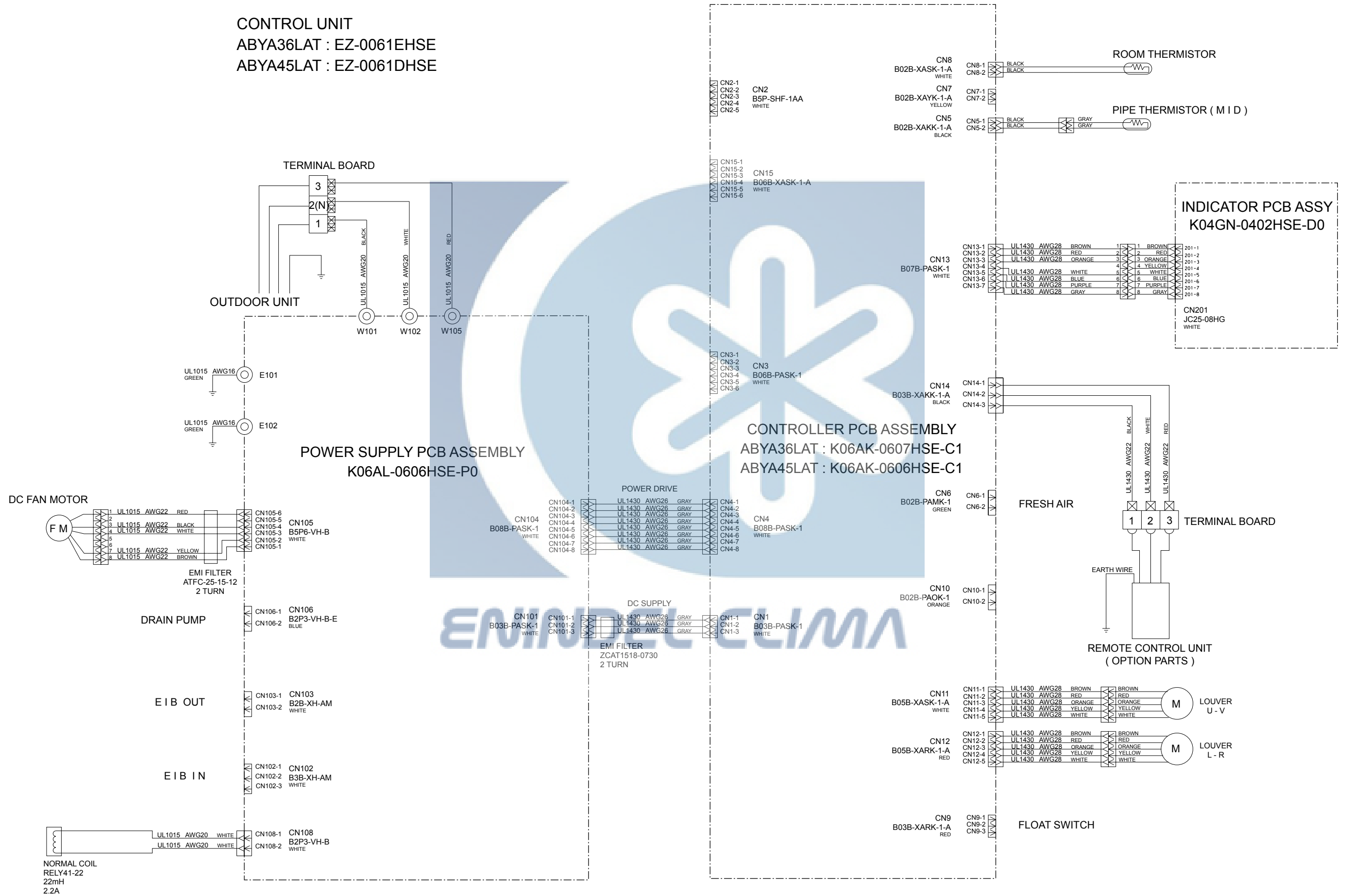

CONTROLLER PCB ASSEMBLY (MAIN PCB)

ABYA36LAT : K06AK-0607HSE-C1

ABYA45LAT : K06AK-0606HSE-C1

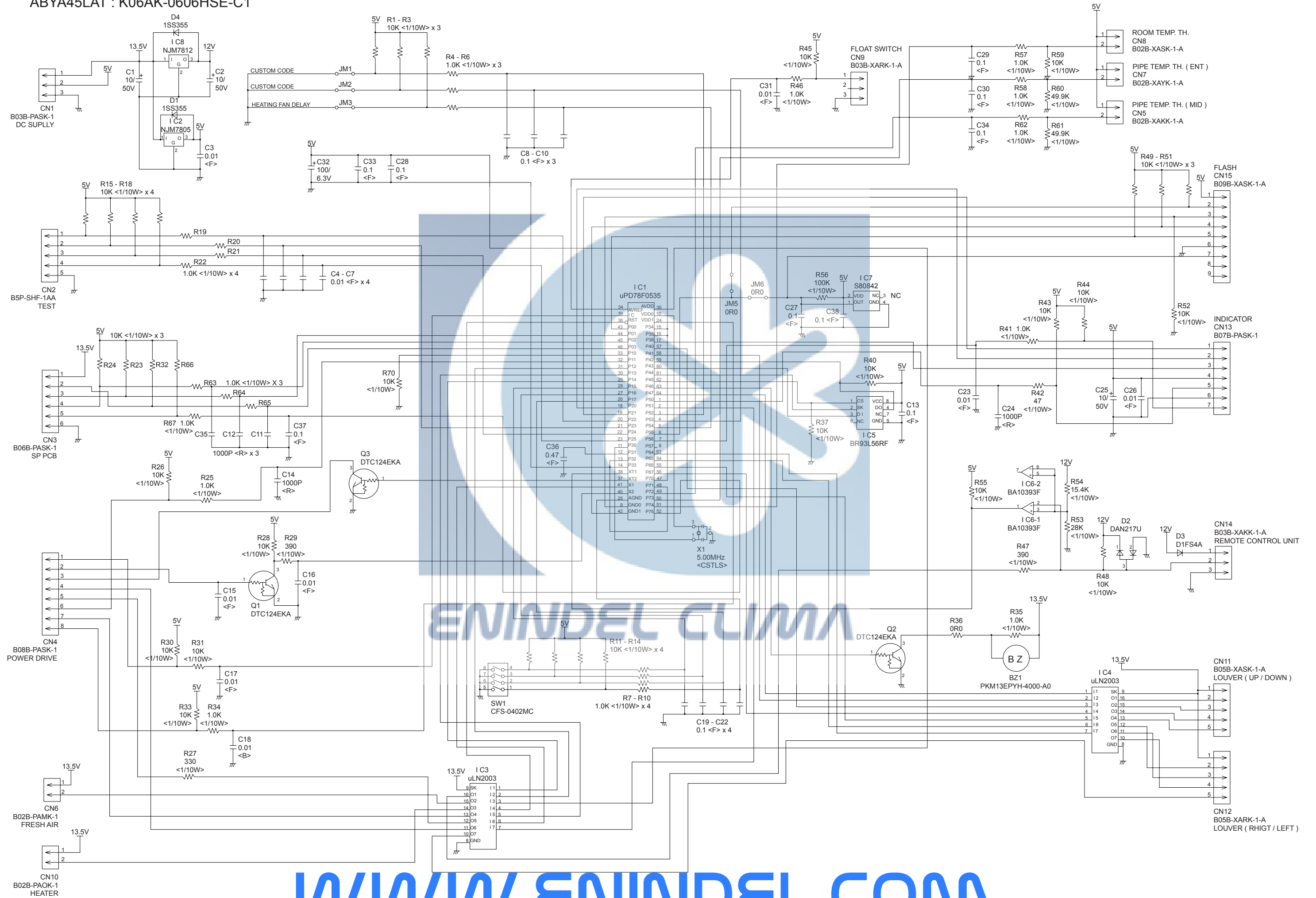

INDOOR UNIT
 POWER SUPPLY PCB ASSEMBLY
 K06AL-0606HSE-P0

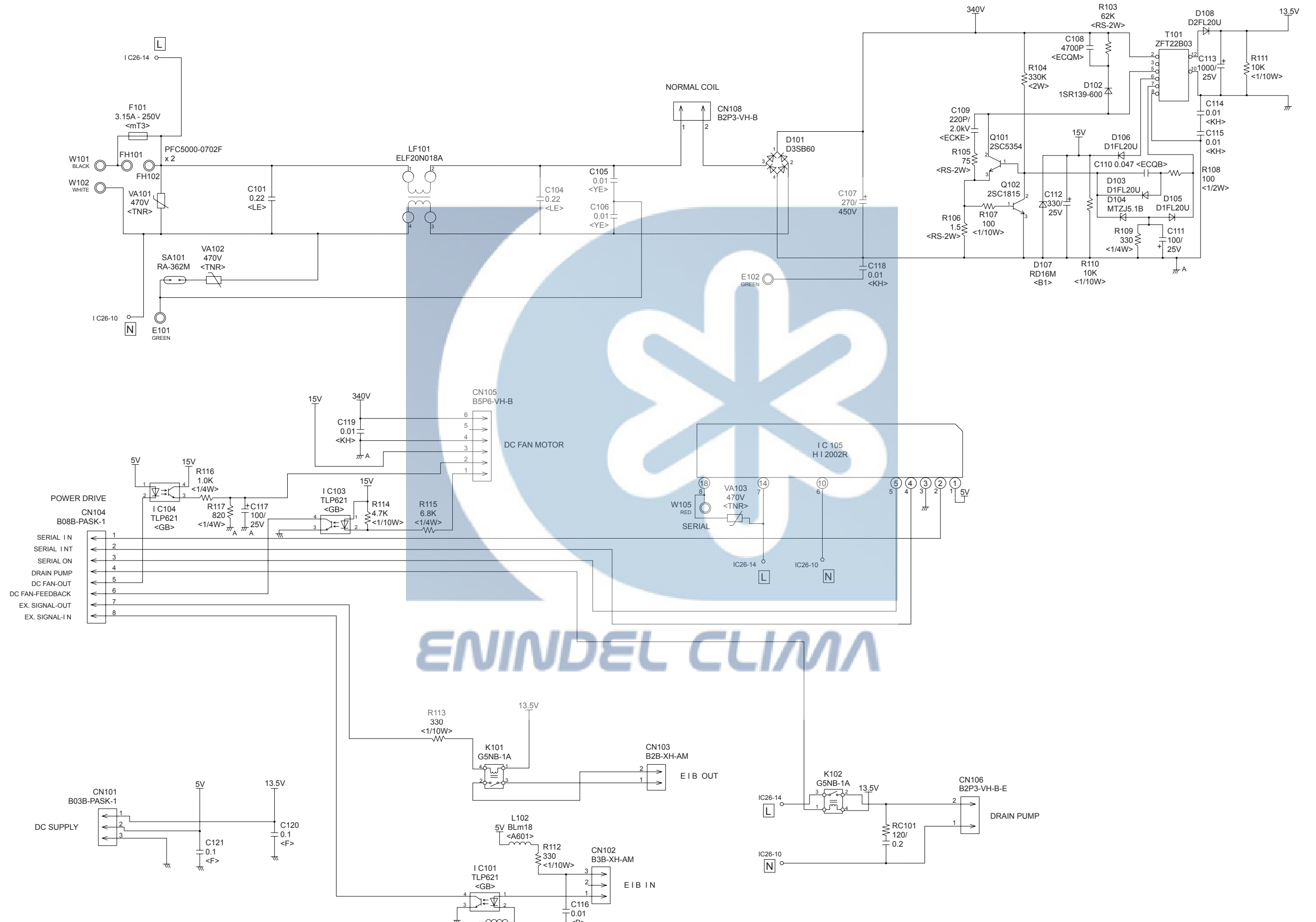

ENINDEL CLIMA

WWW.ENINDEL.COM

INDOOR UNIT
 INDICATOR PCB ASSEMBLY
 K04GN-0402HSE-D0

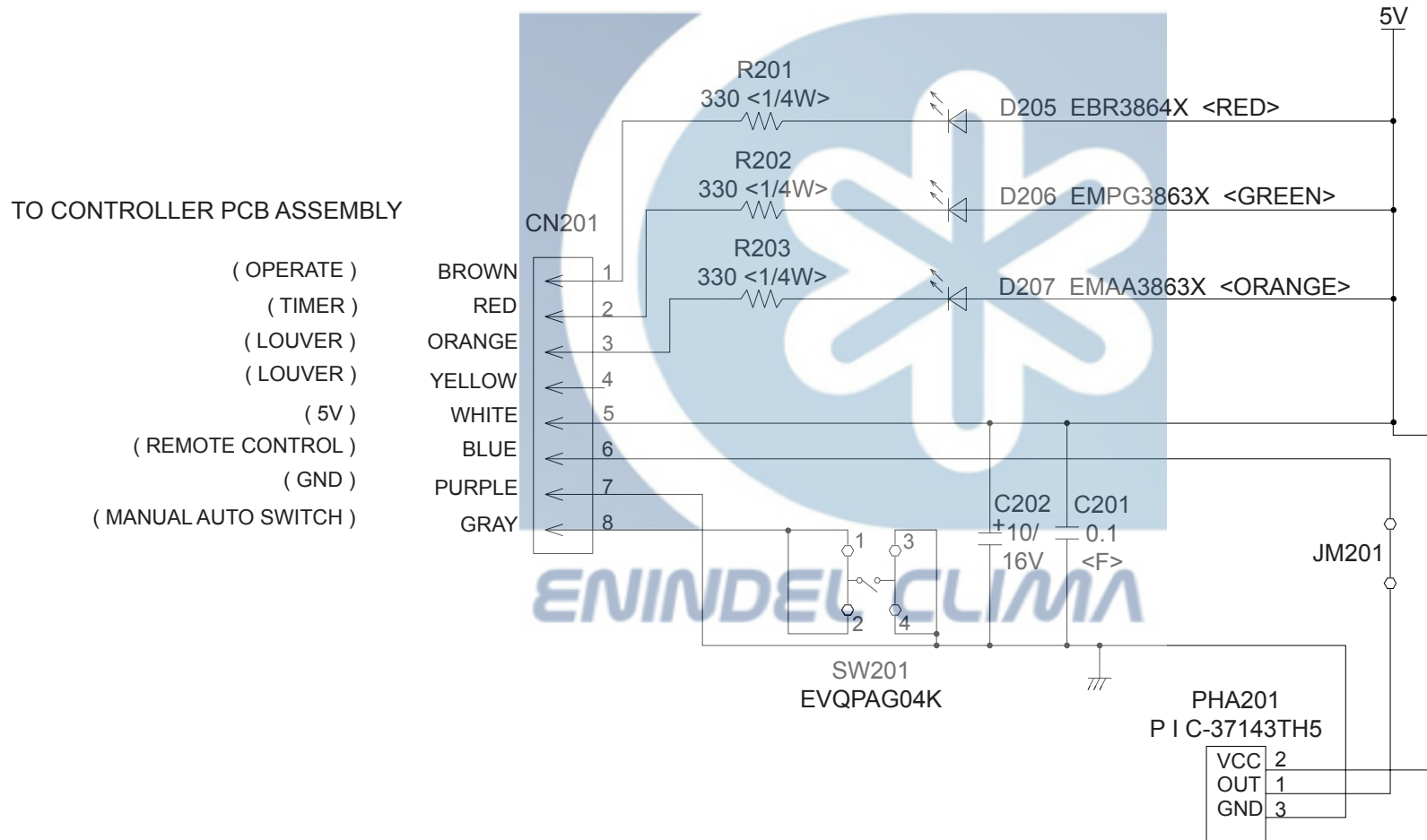

CONTROLLER PCB ASSEMBLY
 AOYA36LATL : K06DZ-0601HUE-C1
 AOYA45LATL : K06DZ-0600HUE-C1

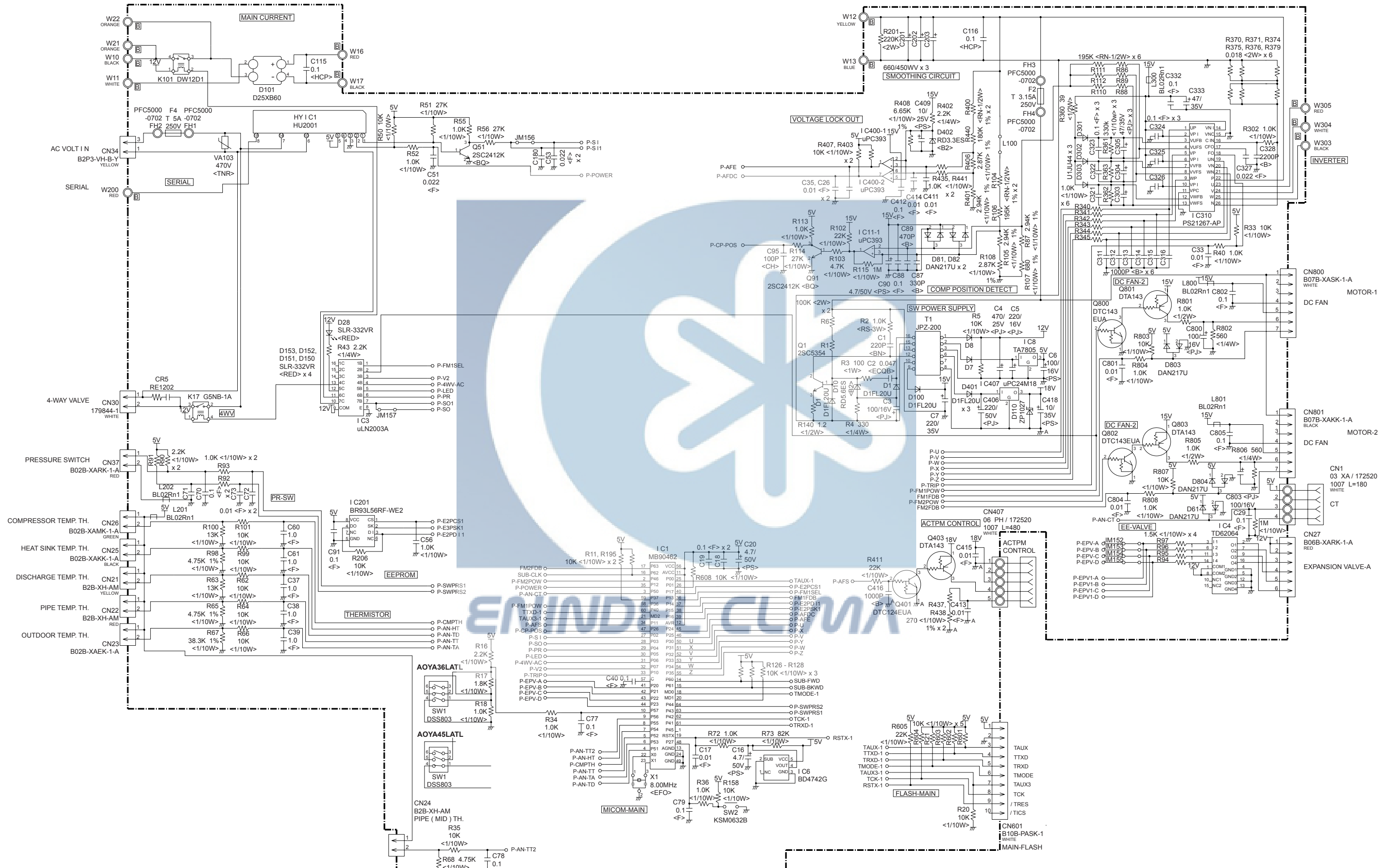

OUTDOOR UNIT
 POWER SUPPLY PCB ASSEMBLY
 K04BA-0401HUE-P0

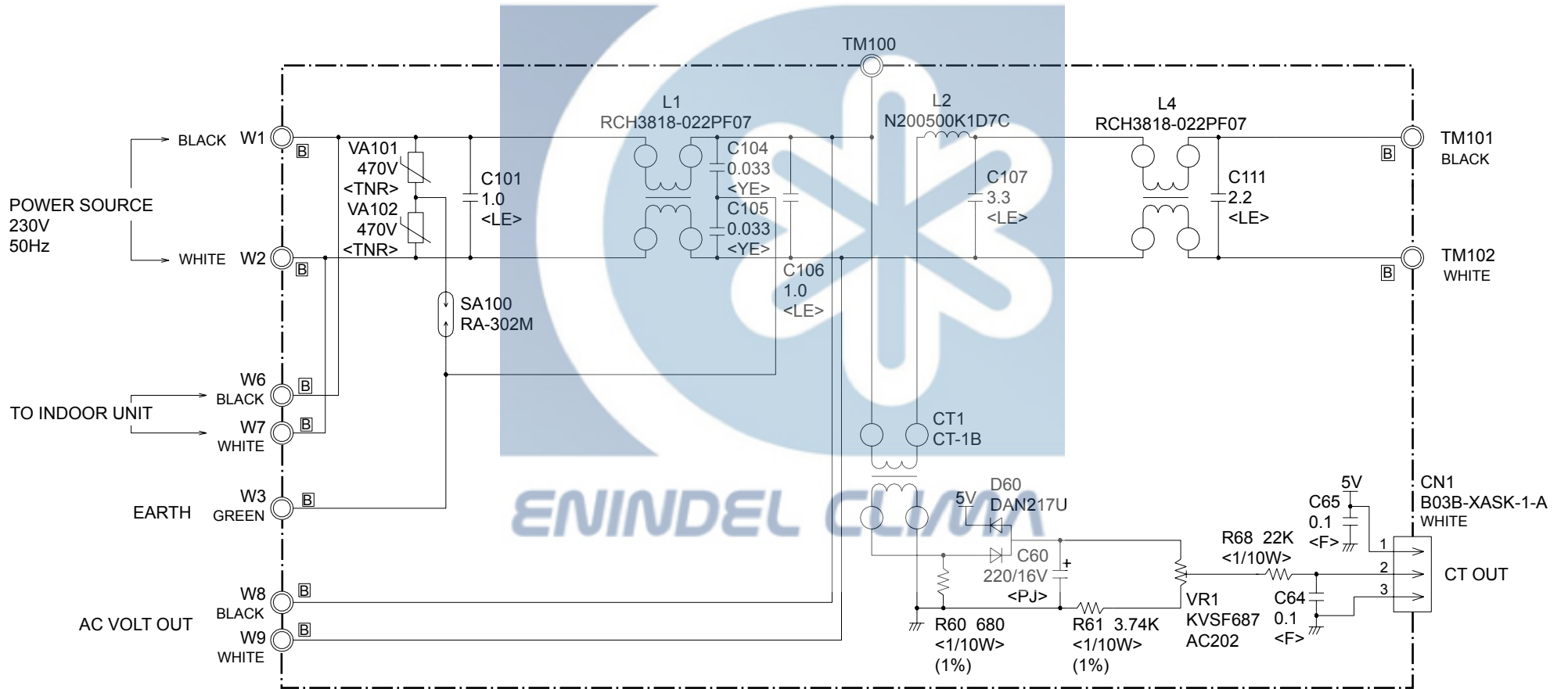

ERROR CONTENTS

INDOOR UNIT

(Troubleshooting with the indoor display)

Troubleshooting at the display is possible either on the wired or wireless remote control.

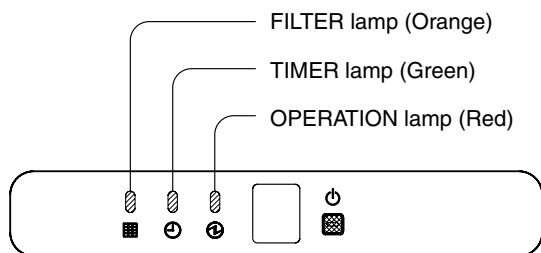

The OPERATION, TIMER and FILTER lamp operate as follows table according to the error contents.

Error contents	OPERATION lamp (RED)	TIMER lamp (GREEN)	FILTER lamp (ORANGE)
Indoor signal error	×	○	×
Wired remote controller abnormal	×	(8 times) ○	×
Indoor room temperature sensor error	(2 times) ○	(2 times) ○	×
Indoor heat exchanger temperature sensor (middle) error	(2 times) ○	(3 times) ○	×
Indoor heat exchanger temperature sensor (inlet) error	(2 times) ○	(4 times) ○	×
Float switch operated	(2 times) ○	(6 times) ○	×
Outdoor discharge pipe temperature sensor error	(3 times) ○	(2 times) ○	×
Outdoor heat exchanger temperature sensor (outlet) error	(3 times) ○	(3 times) ○	×
Outdoor temperature sensor error	(3 times) ○	(4 times) ○	×
Heatsink thermistor error	(3 times) ○	(7 times) ○	×
Compressor temperature sensor error	(3 times) ○	(8 times) ○	×
2-way valve temperature sensor error	(3 times) ○	×	(2 times) ○
3-way valve temperature sensor error	(3 times) ○	×	(3 times) ○
Outdoor heat exchanger temperature sensor (middle) error	(3 times) ○	×	(4 times) ○
Indoor manual auto switch abnormal	(4 times) ○	(2 times) ○	×
Power supply frequency detection error	(4 times) ○	(4 times) ○	×
IPM protection	(5 times) ○	(2 times) ○	×
CT error	(5 times) ○	(3 times) ○	×
Compressor location error	(5 times) ○	(5 times) ○	×
Outdoor fan error	(5 times) ○	(6 times) ○	×
Connected indoor unit abnormal	(5 times) ○	(7 times) ○	×
Outdoor unit computer communication error	(5 times) ○	(8 times) ○	×
Indoor fan abnormal	(6 times) ○	(2 or 3 times) ○	×
Discharge temperature error	(7 times) ○	(2 times) ○	×
Excessive high pressure protection on cooling	(7 times) ○	(3 times) ○	×
4-way valve abnormal	(7 times) ○	(4 times) ○	×
Pressure switch abnormal	(7 times) ○	(5 times) ○	×
Compressor temperature error	(7 times) ○	(6 times) ○	×
Active filter abnormal	(8 times) ○	(2 or 3 times) ○	×
PFC circuit error	(8 times) ○	(4 times) ○	×

○: 0.5s ON/0.5s OFF (Flash) ×: OFF

OUTDOOR UNIT LEDS

Make a TEST RUN in accordance with the installation instruction sheet for the indoor unit.

When a malfunction occurs in the outdoor unit, the LED on the circuit board lights to indicate the error. Refer to the following table for the description of each error according to the LED.

LED	Error contents
1 flash	Communication error (Indoor unit - Outdoor unit)
2 flash	Discharge pipe temperature sensor
3 flash	Outdoor heat exchanger temperature (outlet) sensor
4 flash	Outdoor temperature sensor
5 flash	Outdoor heat exchanger temperature (mid) sensor
6 flash	Discharge pipe temperature abnormal
7 flash	Compressor temperature sensor
8 flash	Heat sink temperature sensor
9 flash	Pressure switch abnormal
10 flash	Compressor temperature abnormal
12 flash	IPM error
13 flash	Compressor rotor position cannot detect
14 flash	Compressor cannot operate
15 flash	Outdoor fan abnormal (upper fan)
16 flash	Outdoor fan abnormal (lower fan)
5 sec. on/ 1 sec. off repeat	Protect operation
1 sec. on/ 1 sec. off repeat	Pump down operation
off	No error

SPECIAL INSTALLATION SETTING

PUMP DOWN (Refrigerant collecting operation)

Perform the following procedures to collect the refrigerant when moving the indoor unit or outdoor unit

1. When the product is stopped:

①	Press the PUMP DOWN switch on the outdoor unit. (The LED on the outdoor unit circuit board starts flashing.) (1 sec. on / 1 sec. off repeated)
②	The pump down operation (cooling operation) begins right away. After operation starts, close the three-way valve (liquid).
③	After 2 - 3 minutes, operation stops. Close the three-way valve (gas) within one minute after operations stops.
④	The LED will go out three minutes after it stops. Disconnect the power supply after confirming that the LED has gone out.

2. When the product is operating:

①	Press the PUMP DOWN switch on the outdoor unit. The LED on the outdoor unit circuit board starts flashing (1 sec. on / 1 sec. off repeated), and operation stops. At this point, recovery has not been completed, so do not close the three-way valves. (liquid and gas)
②	The pump down operation (cooling operation) begins after three minutes. Close the three-way valve (liquid) after operation starts.
③	After 2 - 3 minutes, operation stops. Close the three-way valve (gas) within one minute after operations stops.
④	The LED will go out three minutes after it stops. Disconnect the power supply after confirming that the LED has gone out.

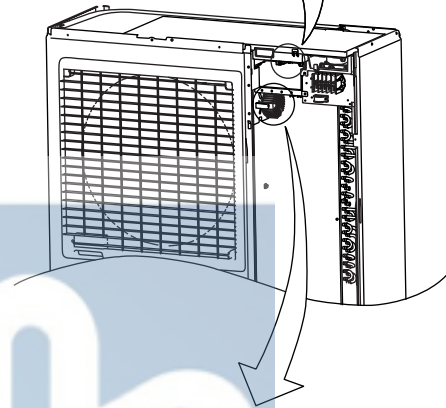
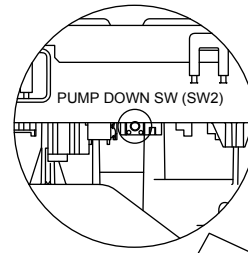

⚠ DANGER

This part (Choke coil) generates high voltages. Never touch this part.

*When the pump down operation is repeated, temporarily disconnect the power supply after opening the closed valves (both liquid and gas). Reconnect the power supply after 2 - 3 minutes and perform the pump down operation.

*When the start of the operation after pump down operation has been completed, temporarily disconnect the power supply after opening the closed valves (both liquid and gas). Reconnect the power supply after 2-3 minutes and be sure to perform a test operation for cooling.

		Tightening torque
Blank cap	6.35 mm (1/4 in.)	20 to 25 N-m (200 to 250 kgf-cm)
	9.52 mm (3/8 in.)	20 to 25 N-m (200 to 250 kgf-cm)
	12.70 mm (1/2 in.)	25 to 30 N-m (250 to 300 kgf-cm)
	15.88 mm (5/8 in.)	30 to 35 N-m (300 to 350 kgf-cm)
	19.05 mm (3/4 in.)	35 to 40 N-m (350 to 400 kgf-cm)
Charging port cap		10 to 12 N-m (100 to 120 kgf-cm)
Spindle (Hexagon wrench)		6 to 7 N-m (60 to 70 kgf-cm)

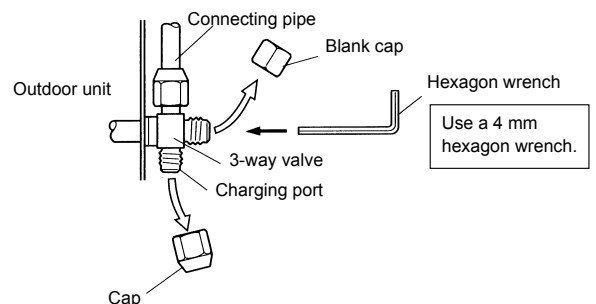
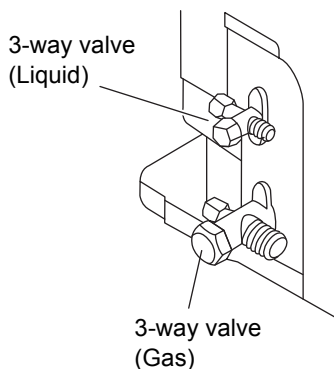

PARTS

INDOOR UNIT

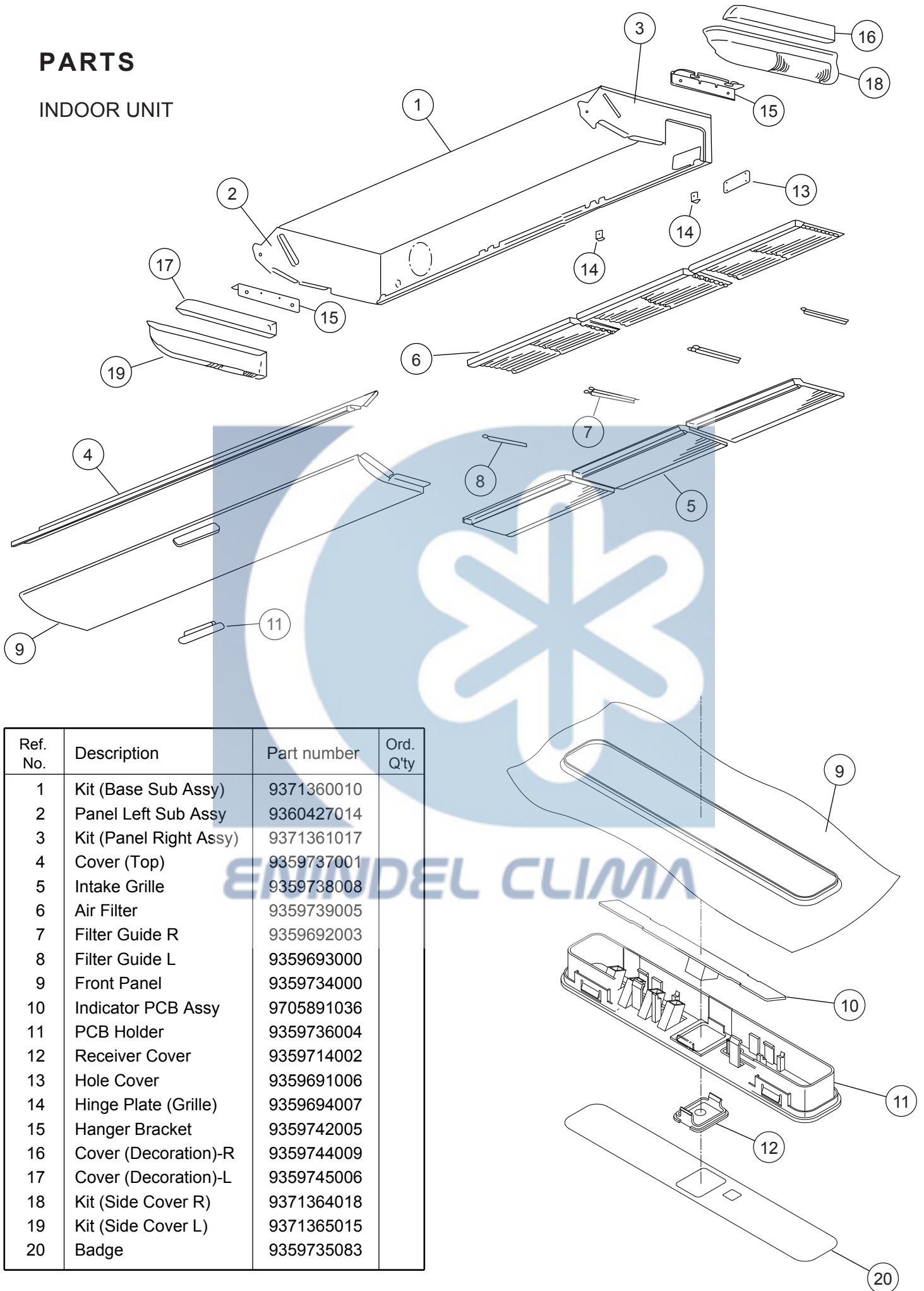

Ref. No.	Description	Part number	Ord. Q'ty
1	Kit (Base Sub Assy)	9371360010	
2	Panel Left Sub Assy	9360427014	
3	Kit (Panel Right Assy)	9371361017	
4	Cover (Top)	9359737001	
5	Intake Grille	9359738008	
6	Air Filter	9359739005	
7	Filter Guide R	9359692003	
8	Filter Guide L	9359693000	
9	Front Panel	9359734000	
10	Indicator PCB Assy	9705891036	
11	PCB Holder	9359736004	
12	Receiver Cover	9359714002	
13	Hole Cover	9359691006	
14	Hinge Plate (Grille)	9359694007	
15	Hanger Bracket	9359742005	
16	Cover (Decoration)-R	9359744009	
17	Cover (Decoration)-L	9359745006	
18	Kit (Side Cover R)	9371364018	
19	Kit (Side Cover L)	9371365015	
20	Badge	9359735083	

INDOOR UNIT

Drain pan

Flap

Ref. No.	Description	Part number	Ord. Q'ty
2	Panel Left Sub Assy	9360427014	
3	Kit (Panel Right Assy)	9371361017	
21	Evaporator Assy	9372585078	
22	Distributor Assy	9371325378	
23	Coupling Pipe Assy	9373038405	
24	Kit (Panel pipe-L) Sub Assy	9371362014	
25	Kit (Panel pipe-R) Sub Assy	9371363011	
26	Reinforcement Metal	9359697008	
27	Drain Pan Sub Assy	9360429018	
28	Flap Assy	9359731009	
29	Bushing	9359733003	
30	Flap Spring	9359730002	
31	Sector Gear	9359729006	
32	Pinion	9359728009	
33	Motor Base	9359727002	
34	Step Motor V	9360307026	
35	Kit (Separate Wall Sub Assy)	9371366029	
36	Pipe Fixture Metal	9359688006	
---	Drain Cap	9358746004	
---	Pipe Thermistor	9900022020	
---	Thermistor Spring A	313728262708	

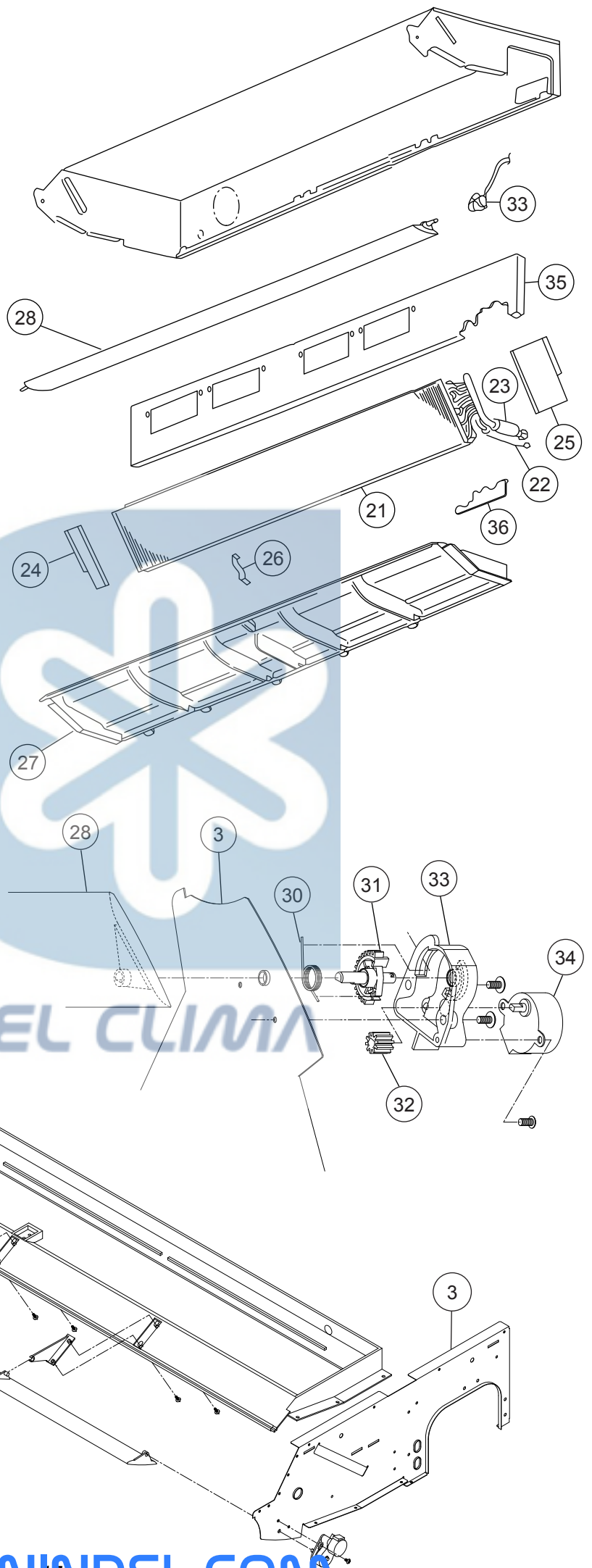

INDOOR UNIT
Louver Base Sub Assy

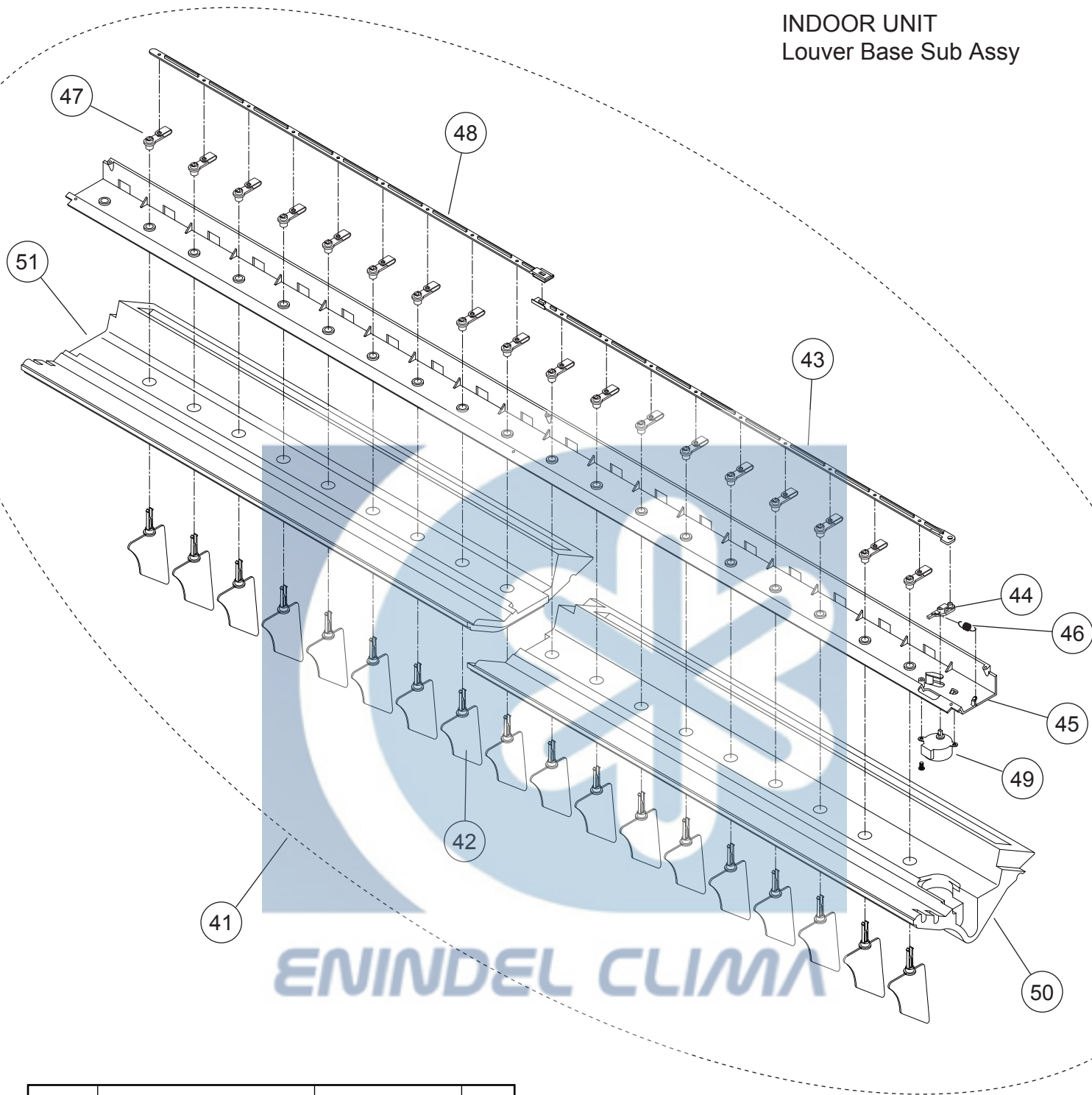

Ref. No.	Description	Part number	Ord. Q'ty
41	Louver Base Sub Assy	9360432025	
42	Louver	9359719007	
43	Rod (Motor)	9359723004	
44	Louver Link	9359726005	
45	Louver Base	9359718000	
46	Louver Spring	9359720003	
47	Louver Stopper	9359724001	
48	Louver Rod	9359725008	
49	Step Motor H	9900297015	
50	Louver Insulation R	9359721000	
51	Louver Insulation L	9359722007	

INDOOR UNIT
Fan motor

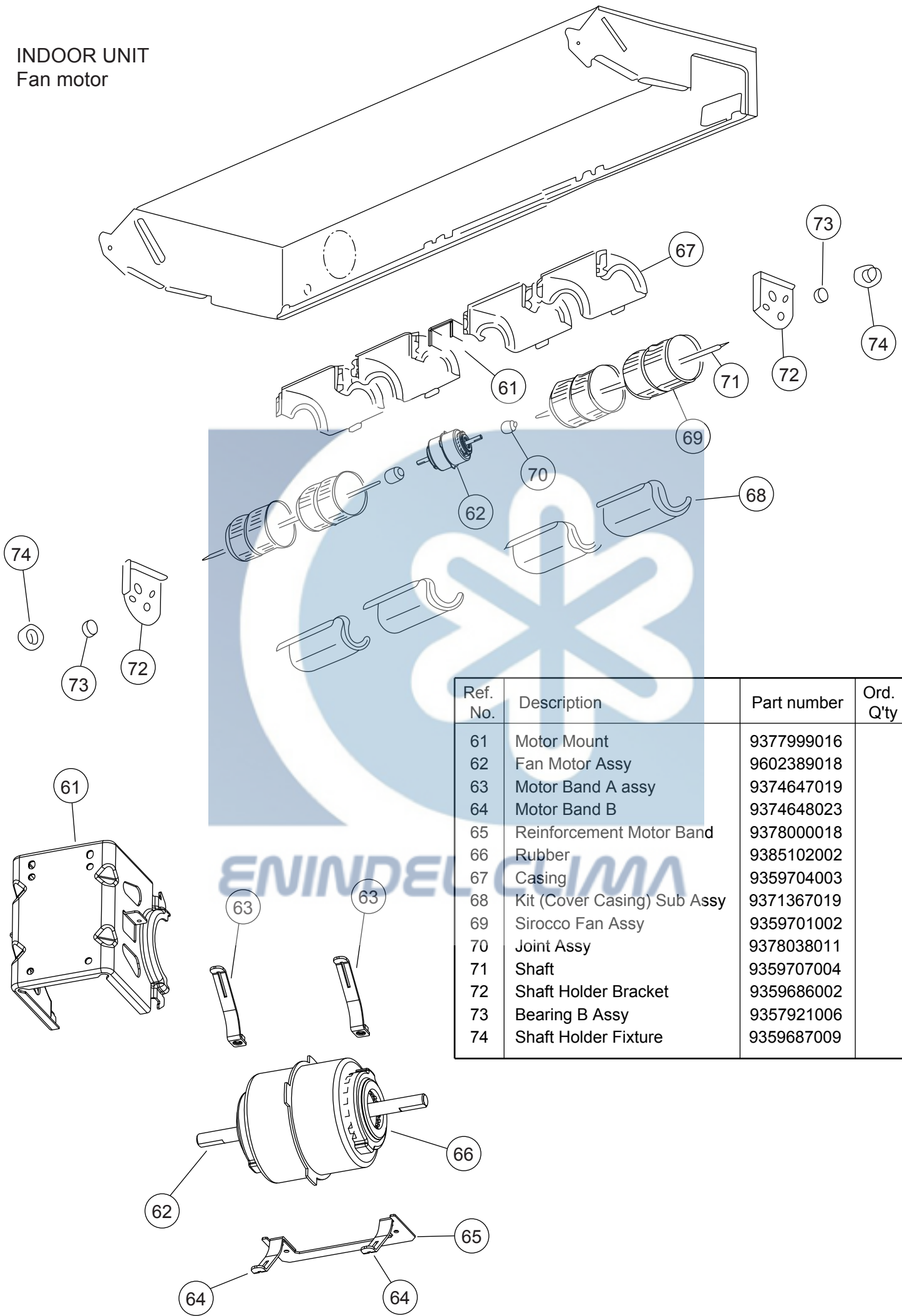

Ref. No.	Description	Part number	Ord. Q'ty
61	Motor Mount	9377999016	
62	Fan Motor Assy	9602389018	
63	Motor Band A assy	9374647019	
64	Motor Band B	9374648023	
65	Reinforcement Motor Band	9378000018	
66	Rubber	9385102002	
67	Casing	9359704003	
68	Kit (Cover Casing) Sub Assy	9371367019	
69	Sirocco Fan Assy	9359701002	
70	Joint Assy	9378038011	
71	Shaft	9359707004	
72	Shaft Holder Bracket	9359686002	
73	Bearing B Assy	9357921006	
74	Shaft Holder Fixture	9359687009	

Ref. No.	Description	Part number	Ord. Q'ty
81	Control Box Assy	9377912015	
82	Control Box A	9359712008	
83	Control Box B	9359713005	
84	Controller PCB Assy (36LATN)	9707393088	
84	Controller PCB Assy (45LATN)	9707393071	
85	Power Supply PCB Assy	9707398076	
86	Terminal 3P	9703345012	
87	Terminal 3P	9306489045	
88	Reactor Assy	9707457018	
89	Rubber Bushing	9357376004	
90	Cord Bushing	9359240006	
91	Cord Clamp-A	9359820017	
92	Cord Clamp-B	9359821014	
93	Reactor Assy	9707457018	
94	Room Thermistor	9703299025	
95	Wire Assy (Connector)	9707442021	
96	Wire Assy (Connector)	9703339028	
97	Wire Assy (Connector)	9702319014	
98	Wire Assy (Connector)	9702318017	
---	Remote Control	9315885012	
---	Remote Control Holder	9305642014	

INDOOR UNIT
Control unit

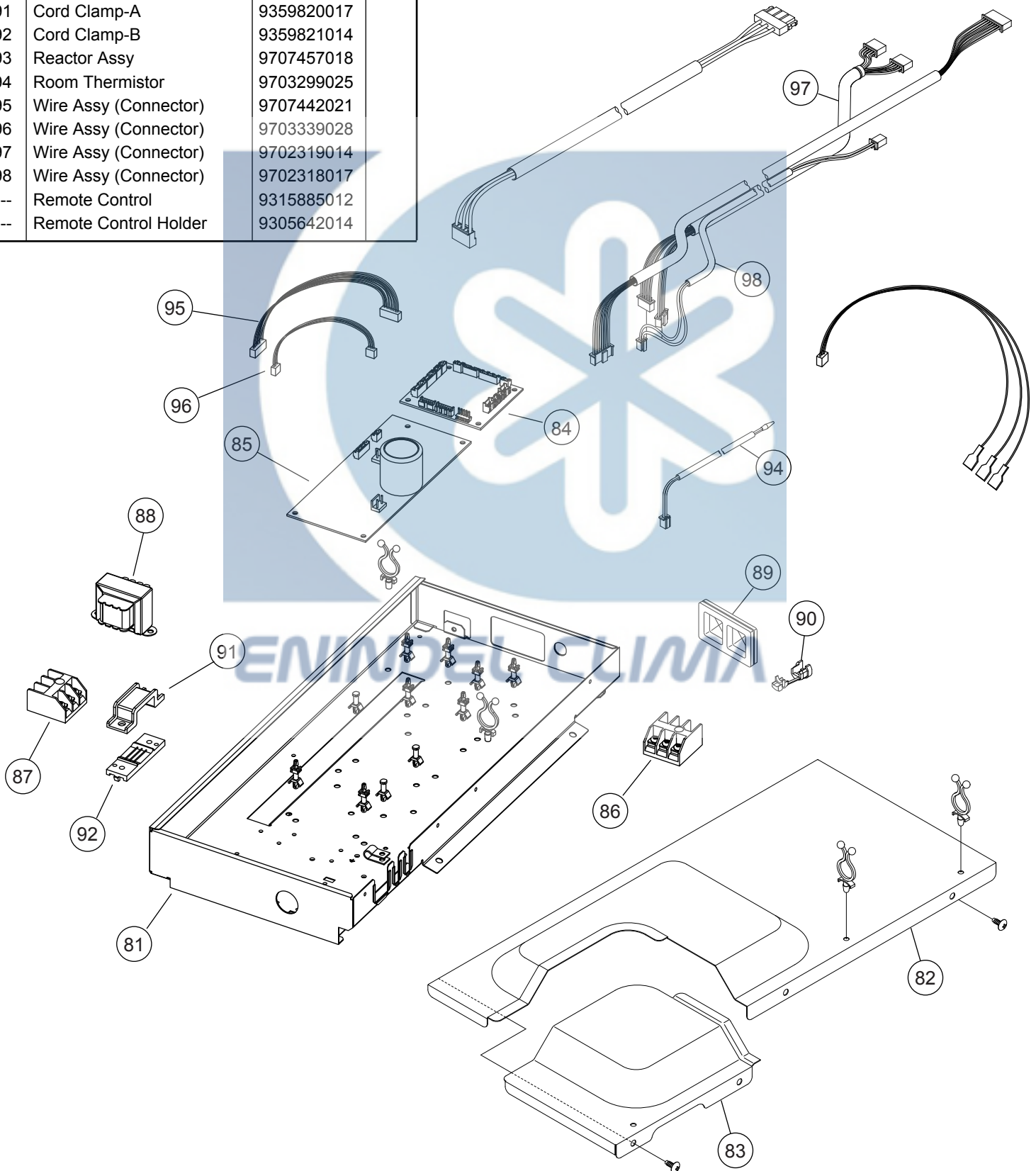

PARTS
OUTDOOR UNIT

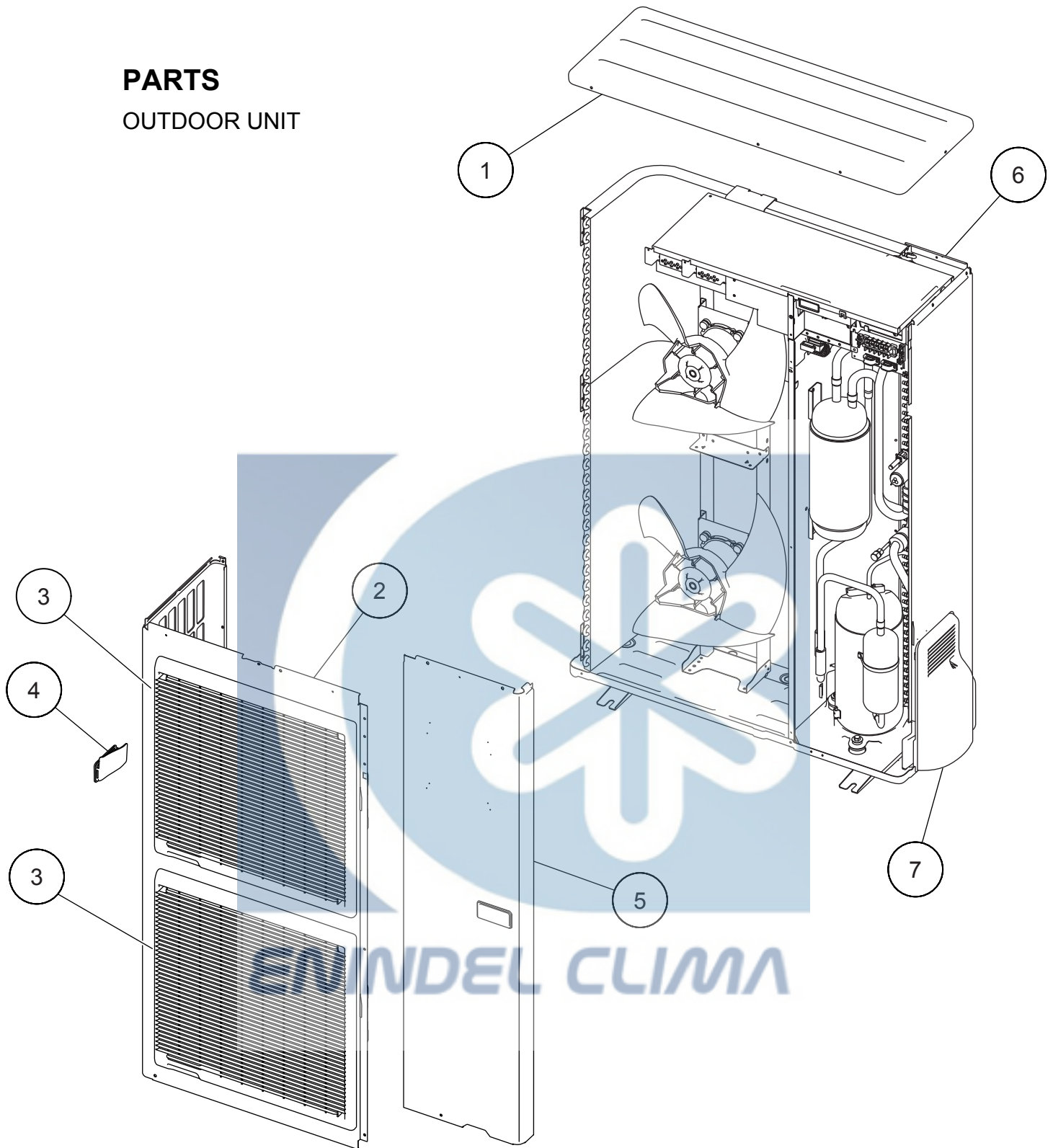

Ref. No.	Description	Parts number	Ord. Q'ty
1	Top Panel Sub Assy	9374417025	
2	Front Panel	9374094028	
3	Fan Guard	9374330010	
4	Grip Side	9374173013	
5	Service Panel Sub Assy	9374415069	
6	Right Panel Sub Assy	9374416141	
7	Valve Cover	9374174010	
--	Emblem Rear	9351355005	

OUTDOOR UNIT

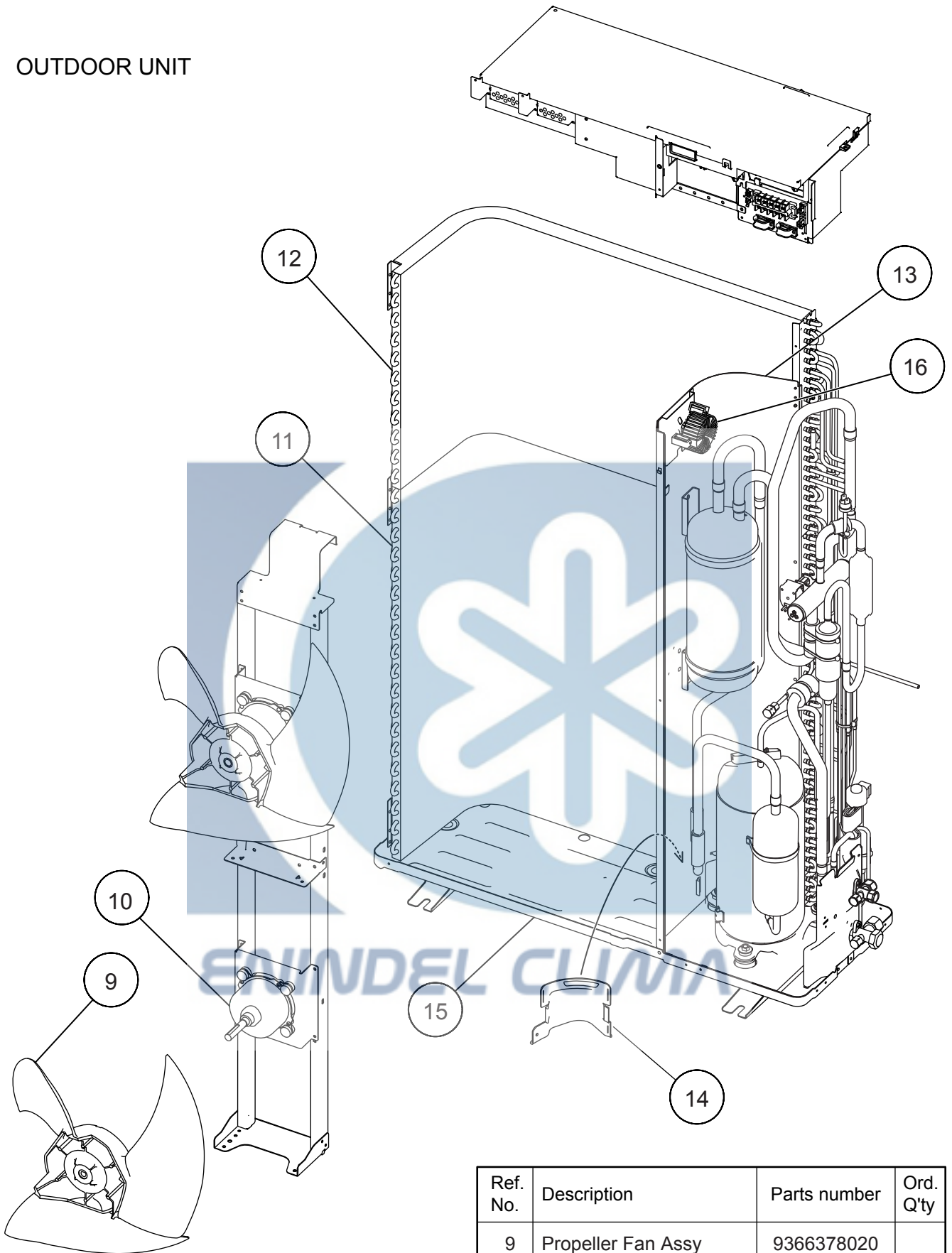

Ref. No.	Description	Parts number	Ord. Q'ty
9	Propeller Fan Assy	9366378020	
10	Motor DC Brushless	9601882015	
11	Condenser A Assy	9374433018	
12	Condenser B Assy	9374434015	
13	Sepa Wall	9374629015	
14	Cap Foot	9374345014	
15	Base Assy	9374166046	
16	Coil Choke	9703458019	

OUTDOOR UNIT

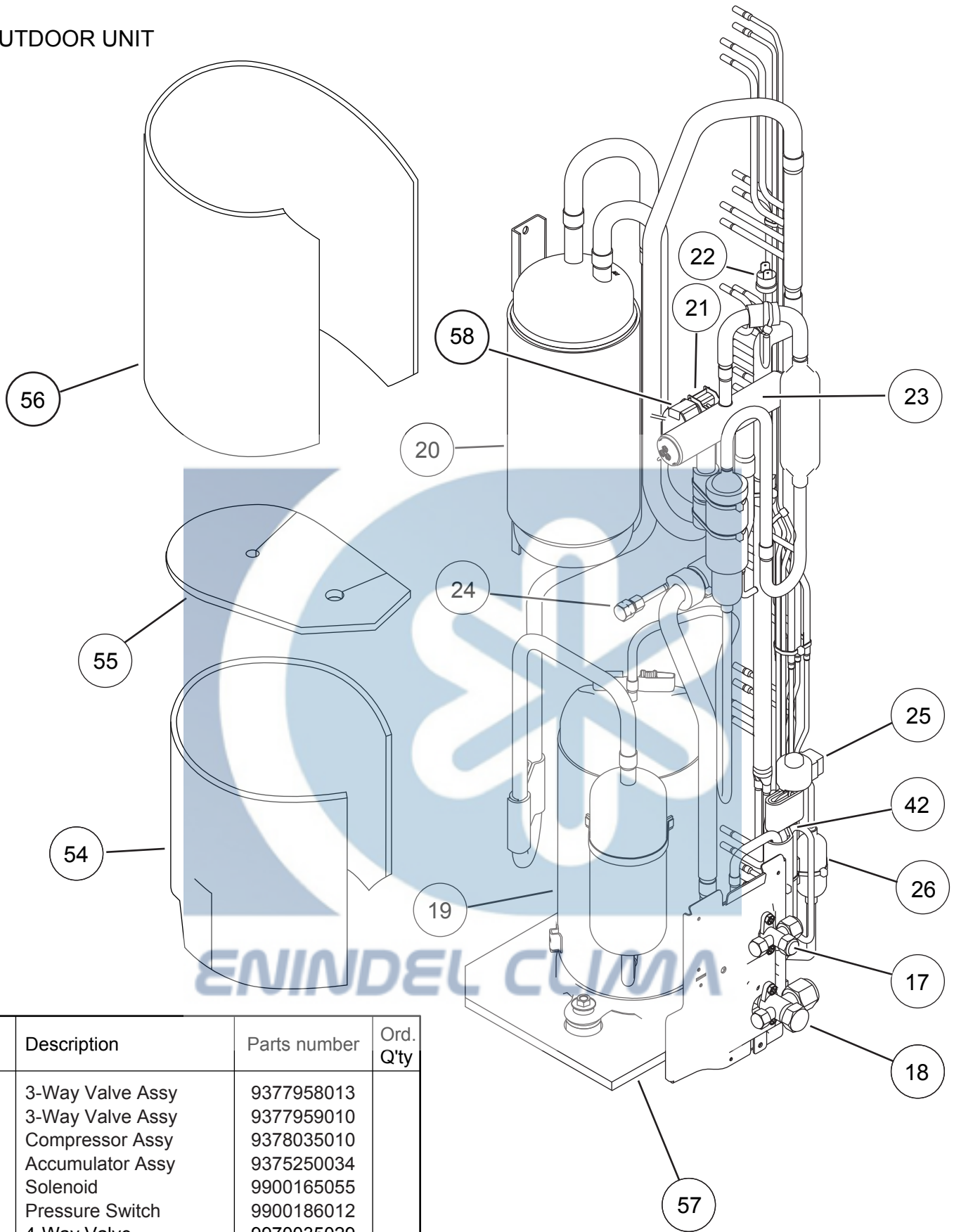

Ref. No.	Description	Parts number	Ord. Q'ty
17	3-Way Valve Assy	9377958013	
18	3-Way Valve Assy	9377959010	
19	Compressor Assy	9378035010	
20	Accumulator Assy	9375250034	
21	Solenoid	9900165055	
22	Pressure Switch	9900186012	
23	4-Way Valve	9970035029	
24	Check Valve Assy	9374274017	
25	Coil (Expansion Valve)	9900197025	
26	Strainer Assy	9372524039	
42	Expansion Valve Assy	9370947175	
54	Compressor Cover A	9374430109	
55	Compressor Cover B	9374431106	
56	Compressor Cover C	9372067086	
57	Compressor Cover D	9375382025	
58	Solenoid	9900165055	





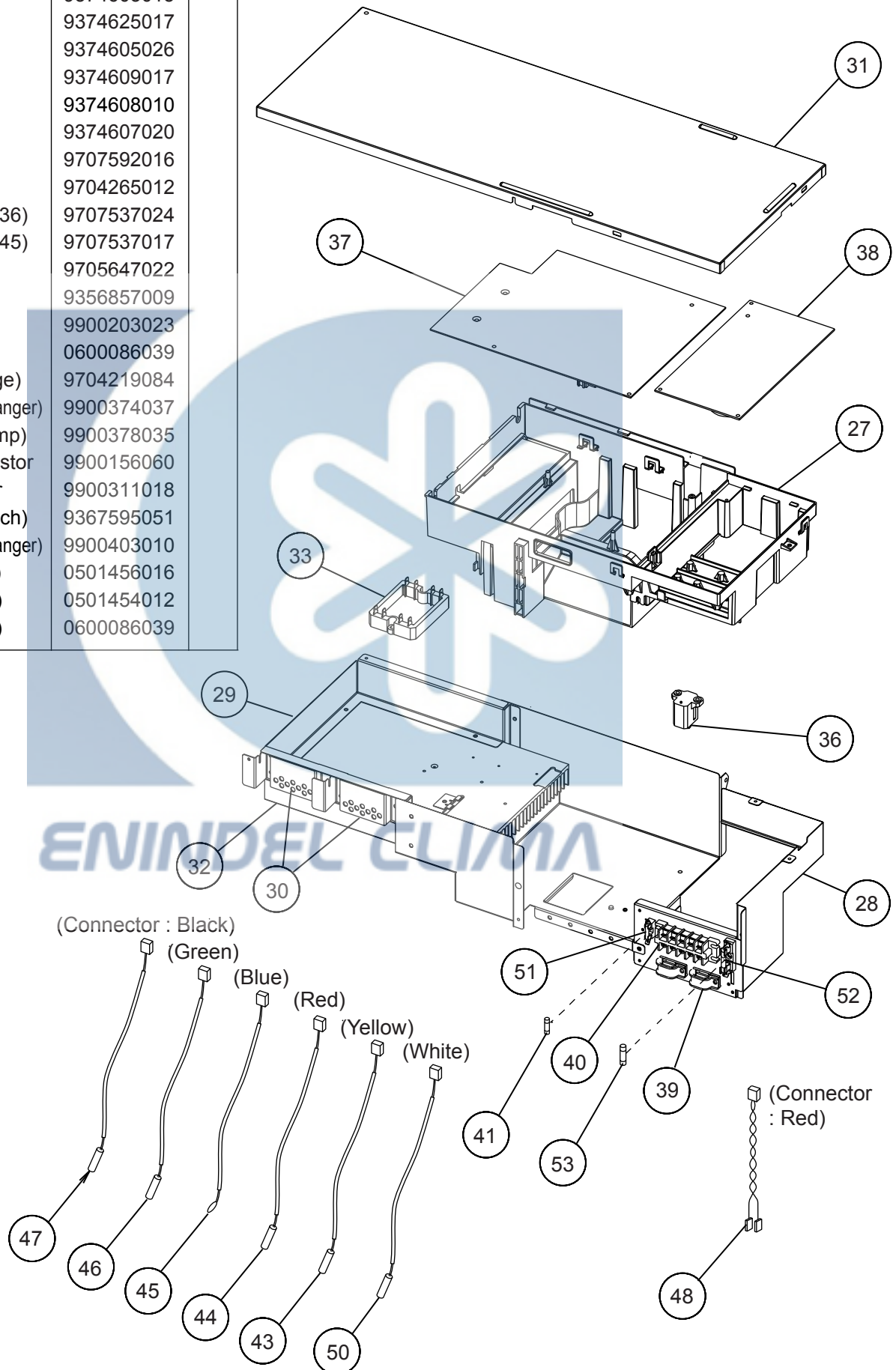

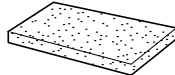

Ref. No.	Description	Parts number	Ord. Q'ty
27	Inverter Box A	9374603015	
28	Inverter Box B	9374625017	
29	Inverter Box C	9374605026	
30	Inverter Box Duct	9374609017	
31	Inverter Box Cover	9374608010	
32	Heat Sink B	9374607020	
33	ACTPM	9707592016	
36	Posistor	9704265012	
37	Inverter PCB Assy (36)	9707537024	
37	Inverter PCB Assy (45)	9707537017	
38	Power PCB Assy	9705647022	
39	Clamp (Cord)	9356857009	
40	Terminal	9900203023	
41	Fuse (Small)	0600086039	
43	Thermistor (Dischage)	9704219084	
44	Thermistor (Heat Exchanger)	9900374037	
45	Thermistor (Out Temp)	9900378035	
46	Compressor Thermistor	9900156060	
47	Heatsink Thermistor	9900311018	
48	Wire (Pressure Switch)	9367595051	
50	Thermistor (Heat Exchanger)	9900403010	
51	Fuse Holder (Small)	0501456016	
52	Fuse Holder (Large)	0501454012	
53	Fuse Holder (Large)	0600086039	

OUTDOOR UNIT

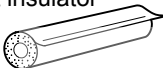
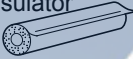



STANDARD ACCESSORIES

INDOOR UNIT

Name and Shape	Q'ty	Application	Part number
Drain hose insulation 	1	Adhesive type 70 x 230	9360464002
VT wire 	1	For fixing the drain hose L 280 mm	313806350303
Coupler heat insulator (large) 	2	For indoor side pipe joint (large pipe)	9350716029
Coupler heat insulator (small) 	1	For indoor side pipe joint (small pipe)	9352766015
Nylon fastener 	Large 4	For fixing the coupler heat insulator	9301501001
	Small 4		312300787605
Special nut A (large flange) 	4	For installing indoor unit	313005446653
Special nut B (small flange) 	4	For installing indoor unit	313005446759
Installation template 	1	For positioning the indoor unit	9360022004
Auxiliary pipe assembly 	1	For connecting the piping	9374714025

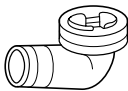
OUTDOOR UNIT

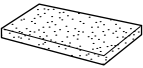
Name and Shape	Q'ty	Application	Part number
Drain pipe 	1	For outdoor unit drain piping work (May not be supplied, depending on the model)	9303029015
Drain cap 	2		313166024302
Installation (seal) 	1	For filling in a gap at the entrance of connection cords	9374756018



0708G3259

WWW.ENINDEL.COM