

OPERATING MANUAL

OPERATING MANUAL
BEDIENUNGSANLEITUNG
MODE D'EMPLOI
MANUAL DE FUNCIONAMIENTO
MANUALE DI ISTRUZIONI
ΕΓΧΕΙΡΙΔΙΟ ΛΕΙΤΟΥΡΓΙΑΣ
MANUAL DE INSTRUÇÕES
РУКОВОДСТВО ПО ЭКСПЛУАТАЦИИ
KULLANMA KİTABI

AIR CONDITIONER

CASSETTE TYPE

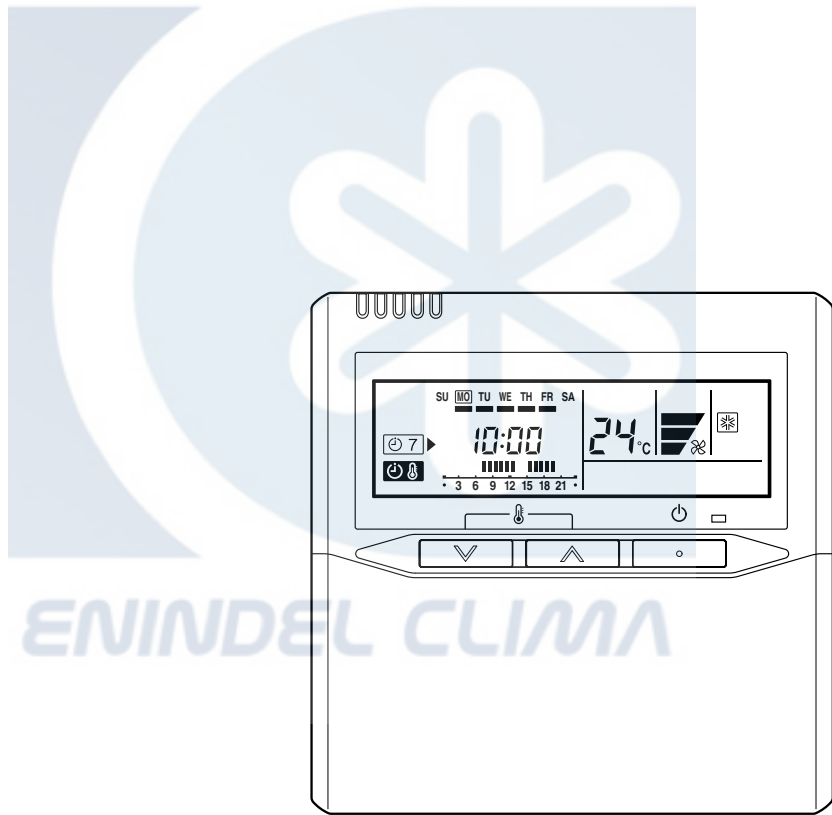

KEEP THIS MANUAL FOR FUTURE REFERENCE

DIESE ANLEITUNG BITTE SORGFÄLTIG AUFBEWAHREN

CONSERVEZ CE MODE D'EMPLOI AFIN DE POUVOIR VOUS Y RÉFÉRER ULTÉRIEUREMENT

GUARDE ESTE MANUAL PARA PODERLO CONSULTAR EN EL FUTURO

CONSERVARE QUESTO MANUALE PER OGNI EVENTUALE FUTURO RIFERIMENTO

ΚΡΑΤΗΣΤΕ ΤΟ ΕΓΧΕΙΡΙΔΙΟ ΓΙΑ ΜΕΛΛΟΝΤΙΚΗ ΑΝΑΦΟΡΑ

GUARDE ESTE MANUAL PARA CONSULTA POSTERIOR

СОХРАНІТЕ НАСТОЯЩЕЕ РУКОВОДСТВО ДЛЯ БУДУЩИХ ССЫЛОК

BU KILAVUZU, DAHA SONRA BAŞVURMAK ÜZERE SAKLAYIN

P/N9372132050

WWW.ENINDEL.COM

English

Deutsch

Français

Español

Italiano

Ελληνικά

Português

Русский



Türkçe

CONTENTS

SAFETY PRECAUTIONS	1	TEMPERATURE SET BACK TIMER	8
NAME OF PARTS	2	OPERATING TIPS	9
PREPARATORY OPERATION	3	ADJUSTING THE DIRECTION OF AIR CIRCULATION	11
OPERATION	3	SWING OPERATION	11
TIMER FUNCTIONS	5	CARE AND MAINTENANCE	12
ON/OFF TIMER	5	SELF-DIAGNOSIS	13
WEEKLY TIMER	6	TROUBLESHOOTING	14

SAFETY PRECAUTIONS

- Before using the appliance, read these "PRECAUTIONS" thoroughly and operate in the correct way.
- The instructions in this section all relate to safety; be sure to maintain safe operating conditions.
- "DANGER", "WARNING" and "CAUTION" have the following meanings in these instructions:

 DANGER!	This mark indicates procedures which, if improperly performed, are most likely to result in the death of or serious injury to the user or service personnel.
 WARNING!	This mark indicates procedures which, if improperly performed, might lead to the death or serious injury of the user.
 CAUTION!	This mark indicates procedures which, if improperly performed, might possibly result in personal harm to the user, or damage to property.

DANGER!

- Do not attempt to install this air conditioner by yourself.
- This unit contains no user-serviceable parts. Always consult authorized service personnel for repairs.
- When moving, consult authorized service personnel for disconnection and installation of the unit.
- Do not become over-exposed to cold air by staying in the direct path of the air flow of the air conditioner for extended periods of time.
- Do not insert fingers or objects into the outlet port or intake grilles.
- Do not start and stop air conditioner operation by turning off the electrical breaker and so on.
- In the event of a malfunction (burning smell, etc.), immediately stop operation, turn off the electrical breaker, and consult authorized service personnel.

CAUTION!

- Provide occasional ventilation during use.
- Do not direct air flow at fireplaces or heating apparatus.
- Do not climb on, or place objects on, the air conditioner.
- Do not hang objects from the indoor unit.
- Do not set flower vases or water containers on top of air conditioners.
- Do not expose the air conditioner directly to water.
- Do not operate the air conditioner with wet hands.
- Turn off power source when not using the unit for extended periods.
- Always turn off the electrical breaker whenever cleaning the air conditioner or changing the air filter.
- Connection valves become hot during Heating; handle with care.
- Check the condition of the installation stand for damage.
- Do not place animals or plants in the direct path of the air flow.
- When restarting after a long period of disuse in the winter, turn the power switch on at least 12 hours before starting the unit.
- Do not drink the water drained from the air conditioner.
- Do not use in applications involving the storage of foods, plants or animals, precision equipment, or art works.
- Do not apply any heavy pressure to radiator fins.
- Operate only with air filters installed.
- Do not block or cover the intake grille and outlet port.
- Ensure that any electronic equipment is at least one metre away from either the indoor or outdoor units.
- Avoid installing the air conditioner near a fireplace or other heating apparatus.
- When installing the indoor and outdoor units, take precautions to prevent access by infants.
- Do not use inflammable gases near the air conditioner.

NAME OF PARTS

Remote controller

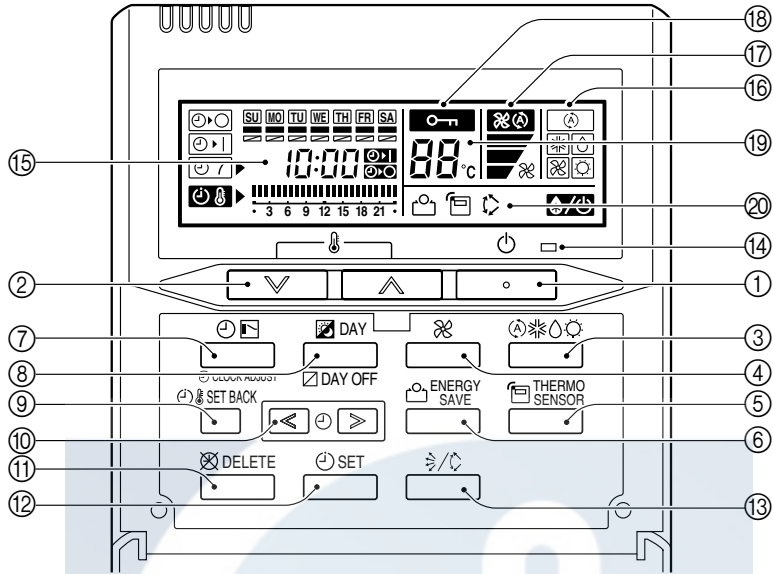

- | | |
|------------------------------------|---|
| ① Start/Stop Button | ⑬ Vertical Airflow Direction and Swing Button |
| ② Set Temperature Button | ⑭ Operation Lamp |
| ③ Master Control Button | ⑮ Timer and Clock Display |
| ④ Fan Control Button | ⑯ Operation Mode Display |
| ⑤ THERMO SENSOR Button | ⑰ Fan Speed Display |
| ⑥ ENERGY SAVE Button | ⑱ Operation Lock Display |
| ⑦ Timer Mode (CLOCK ADJUST) Button | ⑲ Temperature Display |
| ⑧ DAY (DAY OFF) Button | ⑳ Function Display |
| ⑨ SET BACK Button | ☑/⏻ Defrost Display |
| ⑩ Set Time Button | 📅 Thermo Sensor Display |
| ⑪ DELETE Button | 📅 Energy Save Display |
| ⑫ SET Button | ↕/↔ Vertical Swing Display |

PREPARATORY OPERATION

Set the current day and time

1

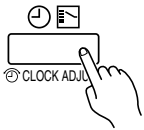

Press the timer mode (CLOCK ADJUST) button for 2 seconds or more. The time display on the remote controller will flash.

2



Press the DAY button and select the current day. A appears around the selected day.

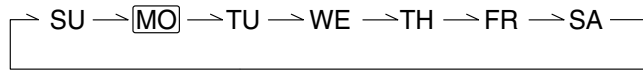

3

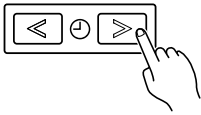

Press the set time buttons to set the current time. Press repeatedly to adjust the current time in 1-minute increments. Press and hold to adjust the current time in 10-minute increments.

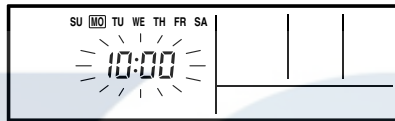

ex. Monday 10:00

4

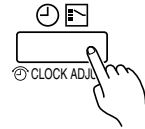

Press again to end.

OPERATION

Instructions relating to heating are applicable only to "HEAT & COOL MODEL" (Reverse Cycle).

To start/stop operation

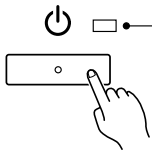

Press the start/stop button.

Operation lamp

Air conditioner ON: Lit brightly
Air conditioner OFF: Not lit

To set the operation mode

● Operation mode setting

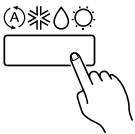

Press the master control button to set the operation mode. If DRY is selected, the fan speed will be set to AUTO.

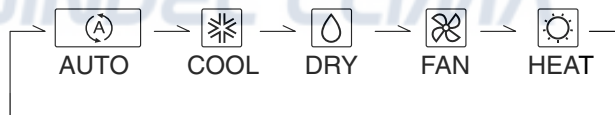

● Room temperature setting

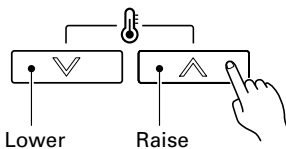

Press the set temperature buttons to set the room temperature.

Temperature setting range

AUTO 18 to 30 °C
COOL/DRY 18 to 30 °C
HEAT 16 to 30 °C

● Fan speed setting

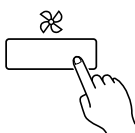

Press the fan control button to set the fan speed.



Energy save

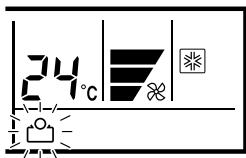

Press the ENERGY SAVE button to start or stop the energy-saving air conditioner operation.
For details on the function, refer to page 9.

Room temperature sensor selection

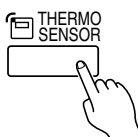

Press the THERMO SENSOR button to select whether the room temperature is detected at the indoor unit (remote sensor) or the remote controller.

When the  thermo sensor display appears, the room temperature is detected at the remote controller.

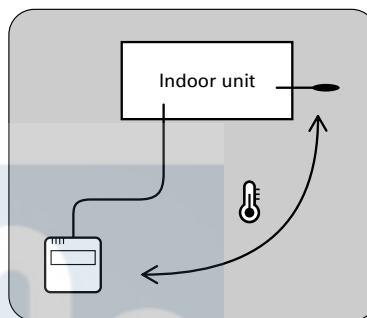

NOTES

- This function is locked at the factory. In order to detect the room temperature correctly, consult authorized service personnel when using this function.
- If this function is locked, the location where the room temperature is detected cannot be changed and the  mark flashes when the THERMO SENSOR button is pushed.

Child lock function

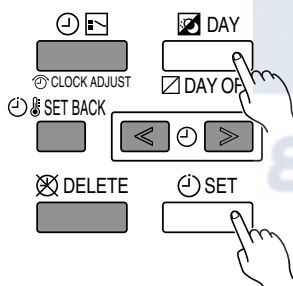

Press the DAY (DAY OFF) button and SET button simultaneously for 2 seconds or more to activate the child lock function and lock all buttons on the remote controller. Press the buttons again for 2 seconds or more to deactivate the child lock function.

When the child lock function is activated, the  mark appears. If any button is pressed during the child lock, the **CL** display flashes.

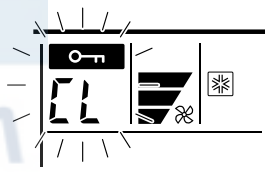

TIMER FUNCTIONS



OFF timer (See page 5.)

Use this timer function to stop air conditioner operation. The timer operates and air conditioner operation stops after the set time has passed. The timer can be set up to 24 hours in advance.



ON timer (See page 5.)

Use this timer function to start air conditioner operation. The timer operates and air condition operation starts after the set time has passed. The timer can be set up to 24 hours in advance.



WEEKLY timer (See page 6.)

Use this timer function to set operating times for each day of the week.

Use the DAY OFF setting to switch off timed operation for a selected day in the coming week.

Because all days can be set together, the weekly timer can be used to repeat the timer settings for all of the days.



Temperature SET BACK timer (See page 8.)

Use this timer function to change the set temperature in the operation times set for each day of the week.

This can be used together with other timer settings.

ON/OFF TIMER

To set the ON/OFF timer

1

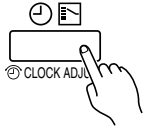

Press the timer mode button to select the ON timer or OFF timer.

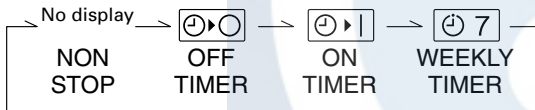

2

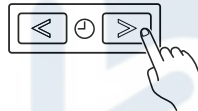

From 1 to 24 hours

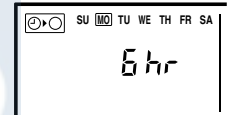

ex. OFF timer set for 6 hours

Press the set time buttons to set the time.

After the time is set, the timer will start automatically. The amount of time until the OFF timer operates that is displayed on the timer display decreases as time passes.

● To cancel



- Press the DELETE button to cancel the timer mode.
- The timer mode can also be canceled by changing the timer mode using the timer mode button.

WEEKLY TIMER

Weekly timer setting

1

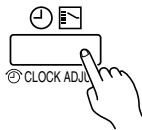

Press the timer mode button to select the weekly timer.

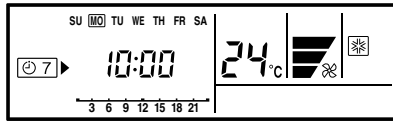

2

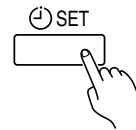

Press the SET button for 2 seconds or more.

3

Day of the week setting

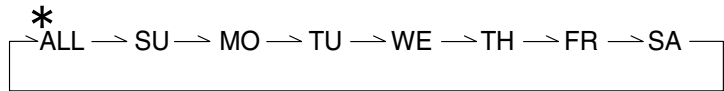
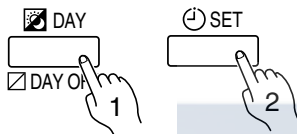

Press the DAY button to select the day of the week, and then press the SET button to confirm the setting.

* For ALL, all of the days can be set together when a appears around each day.

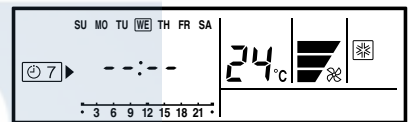

4

Time setting

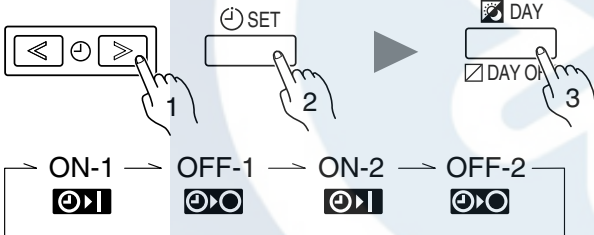

When the operating time is set, the mark appears.

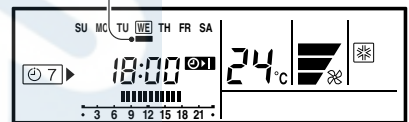

ex. The timer is set for 7:00-18:00.

Press the set time buttons to set the time, and then press the SET button to confirm the setting and proceed to the next ON or OFF time setting.

Up to two ON and OFF times can be set per day.

Press the DAY button to complete the time setting and return to the day of the week setting.

5

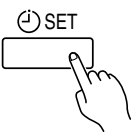

Repeat steps **3** and **4**.

To complete the weekly timer settings, press the SET button for 2 seconds or more.

To delete the operating time



If the DELETE button is pressed during steps **3** or **4**, the operating time for the selected day will be deleted.

If all the days are selected, the operating times for all of the days will be deleted.

NOTES

- The operating time can be set in 30-minute increments only.
- The OFF time can be carried over to the next day.
- The ON timer and the OFF timer functions cannot be set using the weekly timer. Both an ON and OFF time must be set.

WEEKLY TIMER

WEEKLY timer operation

● To start

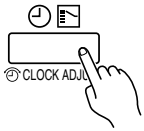

When the weekly timer is selected, the timer starts automatically.

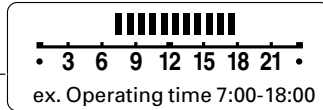
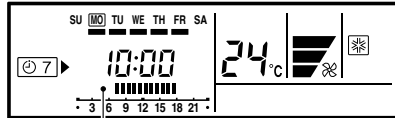

The operating time for the current day is displayed.

● To cancel



- Press the DELETE button to cancel the timer mode.
- The timer mode can also be canceled by changing the timer mode using the timer mode button.

To set the DAY OFF (for a holiday)

1

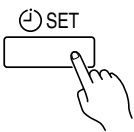

During the weekly timer, press the SET button for 2 seconds or more to set the day.

2



Select the day to set the DAY OFF.

3



Press the DAY (DAY OFF) button for 2 seconds or more to set the DAY OFF.

4

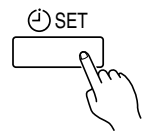

Press the SET button for 2 seconds or more to complete the DAY OFF setting.

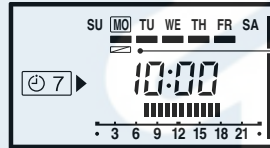
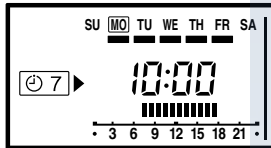

ex. The DAY OFF is set for Monday.

mark: Indicates the DAY OFF

● To cancel

Follow the same procedures as those for setup.

NOTES

- The DAY OFF setting is only available for days for which weekly settings already exist.
- If the operating time carries over to the next day (during a next day setting), the effective DAY OFF range will be set as shown below.

● Normal

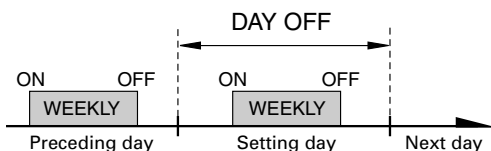

● Next day setting

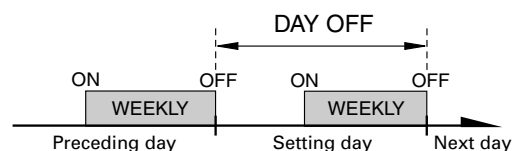

- The DAY OFF setting can only be set one time. The DAY OFF setting is cancelled automatically after the set day has passed.

TEMPERATURE SET BACK TIMER

Temperature SET BACK timer setting

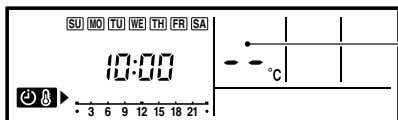
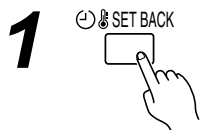

If there is no existing SET BACK temperature setting, “- -” will be displayed for the temperature.

Press the SET BACK button to change to the SET BACK confirmation display. The SET BACK operating time and the set temperature will be displayed.

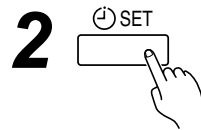

Press the SET button for 2 seconds or more.

3 ● Day setting

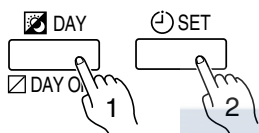

● Operating time setting

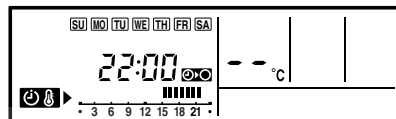
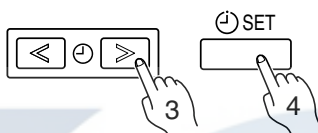

ex. When setting all days together

Follow the same procedures to set the operating time as those for the weekly timer. The DELETE button is also used as described in the procedures for the weekly timer.

4 ● Temperature setting

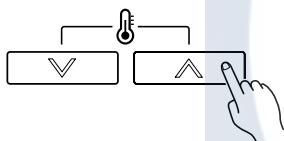

Press the set temperature buttons to set the temperature. (The temperature setting range is the same as the range for the operation mode.)

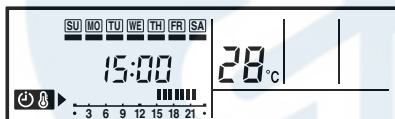

ex. Operating time 15:00-22:00

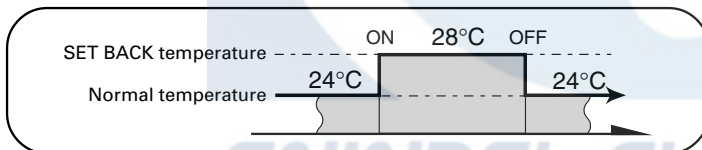

5

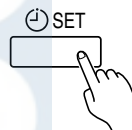

Repeat steps **3** and **4**. Press the SET button for 2 seconds or more to complete the temperature SET BACK timer settings.

Temperature SET BACK timer operation

● To start

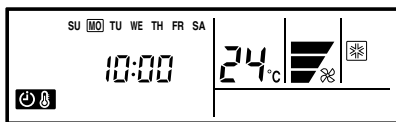

ex. Display during SET BACK timer operation (The operating time will not be displayed.)

Press the SET BACK button. The SET BACK confirmation display appears for 5 seconds, and then the timer starts automatically.

● To cancel

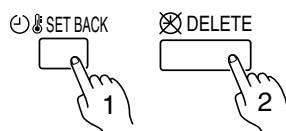

Press the SET BACK button, and then press the DELETE button while the SET BACK confirmation display is displayed. Even if the SET BACK button is pressed again, the SET BACK timer will be cancelled.

i NOTES

- The SET BACK timer only changes the set temperature, it cannot be used to start or stop air conditioner operation.
- The SET BACK timer can be set to operate up to two times per day but only one temperature setting can be used.
- The SET BACK timer can be used together with the ON, OFF, and weekly timer functions.
- The SET BACK operating time is displayed only in the SET BACK confirmation display. (Refer to step 1 for the SET BACK confirmation display.)

OPERATING TIPS

Instructions relating to heating are applicable only to "HEAT & COOL MODEL" (Reverse Cycle).

Mode operation: AUTO

COOLING MODEL

- When the room temperature is 2 °C higher than the set temperature, the mode will switch between Cooling and Drying.
- During the Drying mode operation, the FAN setting should be switched to LOW for a gently cooling effect during which the fan may temporarily stop rotating.

HEAT & COOL MODEL (Reverse Cycle)

Auto changeover function

- When AUTO CHANGEOVER is selected, the air conditioner selects the appropriate operation mode (Cooling or Heating) according to your room's present temperature.
- When AUTO CHANGEOVER is first selected, the fan will operate at a very low speed for about 1 minute while the unit determines the current conditions of the room and selects the proper operation mode.
- When the room temperature is near the thermostat setting, the air conditioner will begin monitor operation. In the monitor operation mode, the fan will operate at a very low speed. If the room temperature subsequently changes, the air conditioner will once again select the appropriate operation (Heating or Cooling) to adjust the temperature to the value set in the thermostat. (The monitor operation range is ± 2 °C relative to the thermostat setting.)

Fan speed: AUTO

Heating: The fan will operate at very low speed when the temperature of the air issued from the indoor unit is low.

Cooling: As the room temperature approaches that of the set temperature, the fan speed becomes slower.

Fan: The fan alternately turns on and off; when on, the fan runs at the low fan speed.

AUTO restart

- Should the power supply to the air conditioner be interrupted by a power failure, the air conditioner will restart automatically in the previously selected mode once the power is restored.
- Use of other electrical appliances (electric shaver, etc.) or nearby use of a wireless radio transmitter may cause the air conditioner to malfunction. In this event, temporarily turn off the circuit breaker turn it on again and then use the remote controller to resume operation.

Heating performance

- This air conditioner operates on the heat-pump principle, absorbing heat from outdoor air and transferring that heat indoors. As a result, the operating performance is reduced as outdoor air temperature drops. If you feel that insufficient heating performance is being produced, we recommend you use this air conditioner in conjunction with another kind of heating appliance.
- Heat-pump air conditioners heat your entire room by recirculating air throughout the room, with the result that some time may be required after first starting the air conditioner until the room is heated.

Energy save

- The energy conservation mode (ENERGY SAVE) raises the set temperature slightly in the cooling mode and lowers the set temperature in the heating mode to economically control the operation of the unit.
- If you press the ENERGY SAVE button while the unit is in the timer mode, the unit will go into the conservation mode when the unit starts with the timer.
- If you turn off the air conditioner while in the conservation mode, the mode will be shut off.
- The temperature set on the remote controller will not change if the energy save mode is used.

During cooling operation

When the ENERGY SAVE is pressed, the thermostat setting is automatically raised 1 °C every 60 minutes, until the thermostat is raised a total of 2 °C.

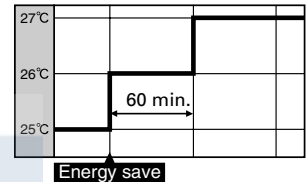

During heating operation

When the ENERGY SAVE is pressed, the thermostat setting is automatically lowered 1 °C every 30 minutes, until the thermostat is lowered a total of 4 °C.

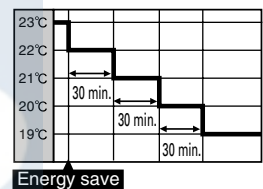

Hot start (for heating)

The indoor unit prevents cold drafts when heating operation begins.

The indoor unit fan will not operate or it will operate at a very low speed until the heat exchanger reaches the set temperature.

Defrosting (for heating)

When the outdoor temperature is low and the humidity high, frost will collect on the outdoor unit, reducing heater efficiency. When this happens, the computer will automatically start the defrost cycle. During the defrost cycle, the indoor fan will shut-down and  will be displayed on the remote controller. It will take anywhere from 4 to 15 minutes before the air conditioner starts up again.

Group Control

One remote controller can control up to 16 air conditioners. All of the air conditioners will be operated with the same settings.

Dual Remote Controllers (optional)



An additional remote controller can be added up to the maximum of two remote controllers. Either remote controller can control the air conditioner. However, the timer functions cannot be used at the slave unit.

Multi-type Air conditioner

This indoor unit can be connected to a multi-type outdoor unit. The multi-type air conditioner allows multiple indoor units to be operated in multiple locations. The indoor units may be operated simultaneously, in accordance with their respective output.

Simultaneous Use of Multiple Units

Instructions relating to inverter (*) are applicable only to "INVERTER MODEL".

- When using a multi-type air conditioner, the multiple indoor units can be operated simultaneously, but when two or more indoor units of the same group are operated simultaneously, the heating and cooling efficiency will be less than when a single indoor unit is used alone. Accordingly, when you wish to use more than one indoor unit for cooling at the same time, the use should be concentrated at night and other times when less output is required. In the same way, when multiple units are used simultaneously for heating, it is recommended that they be used in conjunction with other auxiliary space heaters, as required.
- Seasonal and outdoor temperature conditions, the structure of the rooms and the number of persons present may also result in differences of operating efficiency. We recommend that you try various operating patterns in order to confirm the level of heating and cooling output provided by your units, and use the units in the way that best matches your family's lifestyle.
- If you discover that one or more units delivers a low level of cooling or heating during simultaneous operation, we recommend that you stop simultaneous operation of the multiple units.
- ✦ ● Operation cannot be done in the following different operating modes.
If the indoor unit is instructed to do an operating mode that it cannot perform,  will be shown on the remote controller display and the unit will go into the standby mode.
 - Heating mode and cooling mode (or dry mode)
 - Heating mode and fan mode
- ✦ ● Operation can be done in the following different operating modes.
 - Cooling mode and dry mode
 - Cooling mode and fan mode
 - Dry mode and fan mode
- ✦ ● The operating mode (heating mode or cooling (dry) mode) of the outdoor unit will be determined by the operating mode of the indoor unit that was operated first. If the indoor unit was started in fan mode, the operating mode of the outdoor unit will not be determined.
For example, if indoor unit (A) was started in fan mode and then indoor unit (B) was then operated in heating mode, indoor unit (A) would temporarily start operation in fan mode but when indoor unit (B) started operating in heating mode,  will be shown on the remote controller display and it would go into standby mode. Indoor unit (B) would continue to operate in heating mode.

Notice

Instructions relating to heating (*) are applicable only to "HEAT & COOL MODEL" (Reverse Cycle).

- *● During use of the heating mode, the outdoor unit will occasionally commence the defrost operation for brief periods. During the defrosting operation, if the user sets the indoor unit for heating again, the defrosting mode will continue, and the heating operation will begin after completion of defrosting, with the result that some time may be required before warm air is emitted.
- *● During use of the heating mode, the top of the indoor unit may become warm, but this is due to the fact that coolant is circulated through the indoor unit even when it is stopped; it is not a malfunction.

ADJUSTING THE DIRECTION OF AIR CIRCULATION

Instructions relating to heating are applicable only to "HEAT & COOL MODEL" (Reverse Cycle).

Start air conditioner operation before performing this procedure.

To adjust the vertical airflow direction

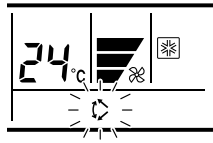
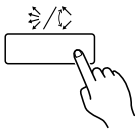

Press the vertical airflow direction and swing button.

The vertical swing display flashes each time the vertical airflow direction and swing button is pressed.

Each time the button is pressed, the airflow direction setting changes as shown in the following figure.

① → ② ← ③ → ④

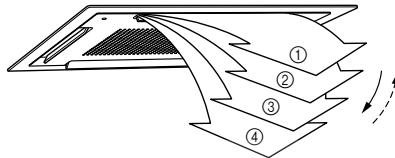

NOTES

- The airflow direction is set automatically according to the operation selected.
During Cooling/Dry mode: Horizontal airflow ①
During Heating mode: Downward airflow ④
- During AUTO mode, the airflow direction will be set to horizontal airflow ① for the first minute of air conditioner operation. The airflow direction cannot be changed during this time.
- Always use the remote controller vertical airflow direction and swing button to adjust the vertical airflow direction louvers. Attempting to adjust them manually could result in improper operation. If the louvers are not operating properly, turn off the air conditioner and restart it.
- When using the air conditioner in a room with infants, small children, or elderly or sick persons, the airflow direction and room temperature should be considered carefully when making the settings.

SWING OPERATION

Start air conditioner operation before performing this procedure.

To select/stop swing operation

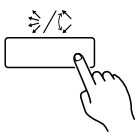

Press the vertical airflow direction and swing button for 2 seconds or more to select or stop swing operation.

The vertical swing display appears during swing operation.

The range of swing depends on the set airflow direction.

Airflow direction setting	Range of swing
①	① to ③
②, ③	② to ④
④	① to ④ (full range)

NOTES

- To change the range of swing, use the remote controller vertical airflow direction and swing button.
- The swing operation may stop temporarily when the air conditioner fan is not operating or when it is operating at very low speeds.

CARE AND MAINTENANCE

⚠ CAUTION!

- Before cleaning the unit, be sure to stop the unit and power supply. (Turn off the electrical breaker)
- A fan operates at high speed inside the unit, and personal injury could result.

Cleaning the air filter

- 1** Push the intake grille pushbuttons (two places) and open the intake grille.

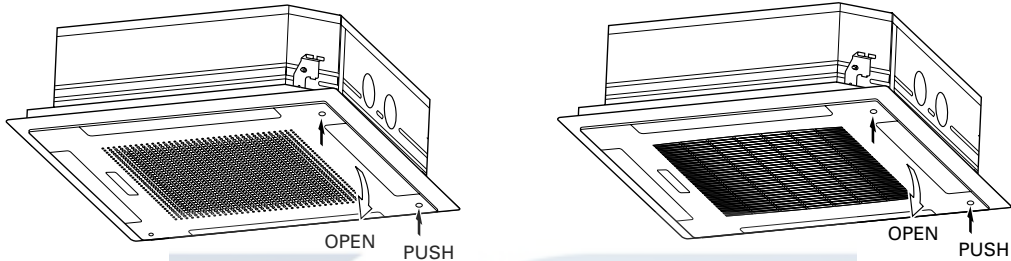

- 2** Hold down the hook at A and pull the filter out.

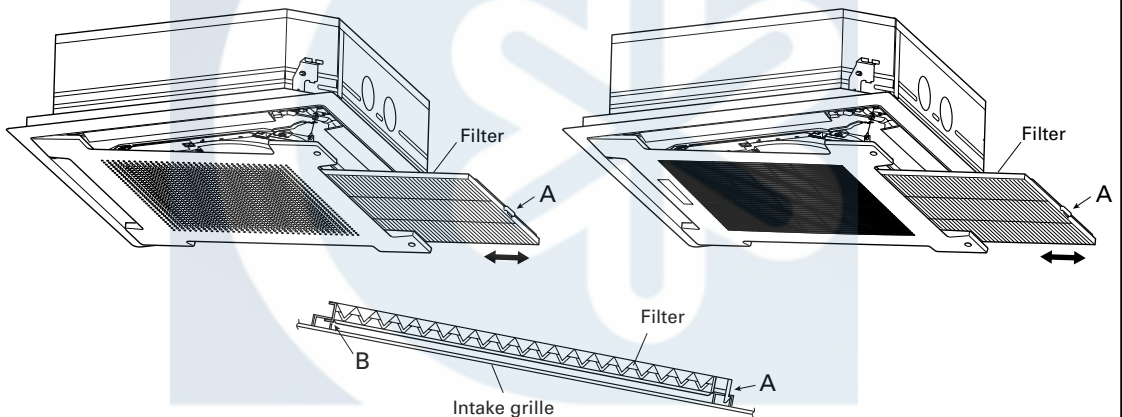

When reinstalling the filter, be sure that the hooks at A and B engage correctly into place.

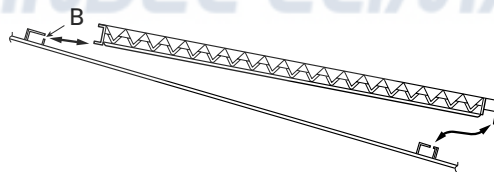

- 3** Clean the air filters.
Remove the dust from the air filters by vacuuming or washing them. After washing, allow the air filters to dry thoroughly in an area protected from sunlight.

i NOTES

- Dust can be cleaned from the air filter either with a vacuum cleaner, or by washing the filter in a solution of mild detergent and warm water. If you wash the filter, be sure to allow it to dry thoroughly in a shady place before reinstalling.
- If dirt is allowed to accumulate on the air filter, air flow will be reduced, lowering operating efficiency and increasing noise.
- During periods of normal use, the air filters should be cleaned every two months.

CARE AND MAINTENANCE

How to cleaning

- When used for extended periods, the unit may accumulate dirt inside, reducing its performance. We recommend that the unit be inspected regularly, in addition to your own cleaning and care. For more information, consult authorized service personnel.
- When cleaning the unit's body, do not use water hotter than 40 °C, harsh abrasive cleansers, or volatile agents like benzene or thinner.
- Do not expose the unit body to liquid insecticides or hairsprays.
- If the unit will not be operated for a period of one month or more, be sure to allow the inner parts of the unit to dry thoroughly, in advance, by operating the unit in fan mode for half a day.

SELF-DIAGNOSIS

When the error indication "E:EE" is displayed, inspection of the air conditioning system is necessary. Please consult authorized service personnel.

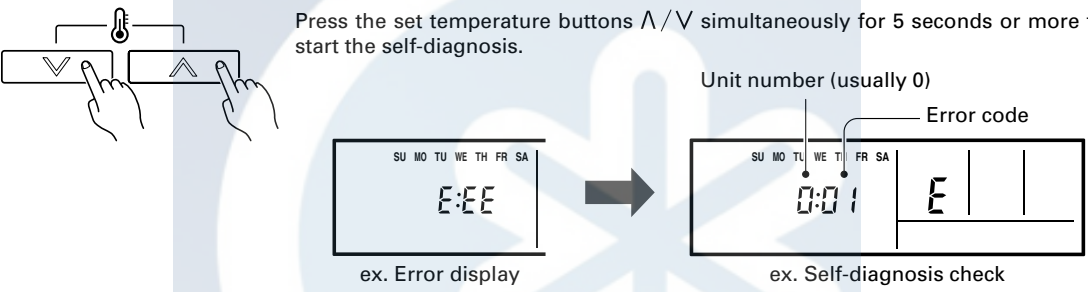
1	Stop the air conditioner operation.
2	<p>Press the set temperature buttons \wedge/\vee simultaneously for 5 seconds or more to start the self-diagnosis.</p> 
3	Press the set temperature buttons simultaneously for 5 seconds or more to stop the self-diagnosis.

TROUBLESHOOTING



Instructions relating to heating are applicable only to "HEAT & COOL MODEL" (Reverse Cycle).

⚠ WARNING!

In the event of a malfunction (burning smell, etc.), immediately stop operation, turn off the electrical breaker, and consult authorized service personnel.

Merely turning off the unit's power switch will not completely disconnect the unit from the power source. Always be sure to turn off the electrical breaker to ensure that power is completely off.

Before requesting service, perform the following checks:

	Symptom	Problem	See page
NORMAL FUNCTION	Doesn't operate immediately:	<ul style="list-style-type: none"> ● If the unit is stopped and then immediately started again, the compressor will not operate for about 3 minutes, in order to prevent fuse blowouts. ● Whenever the electrical breaker is turned off then on again, the protection circuit will operate for about 3 minutes, preventing unit operation during that period. 	—
	Noise is heard:	<ul style="list-style-type: none"> ● During operation and immediately after stopping the unit, the sound of water flowing in the air conditioner's piping may be heard. Also, noise may be particularly noticeable for about 2 to 3 minutes after starting operation (sound of coolant flowing). ● During operation, a slight squeaking sound may be heard. This is the result of minute expansion and contraction of the panel due to temperature changes. 	—
		<ul style="list-style-type: none"> ● During Heating operation, a sizzling sound may be heard occasionally. This sound is produced by the Automatic Defrosting operation. 	9
	Smells:	<ul style="list-style-type: none"> ● Some smell may be emitted from the indoor unit. This smell is the result of room smells (furniture, tobacco, etc.) which have been taken into the air conditioner. 	—
	Mist or steam are emitted:	<ul style="list-style-type: none"> ● During Cooling, a thin mist may be seen emitted from the indoor unit. This results from the sudden Cooling of room air by the air emitted from the air conditioner, resulting in condensation and misting. 	—
		<ul style="list-style-type: none"> ● During Heating operation, the outdoor unit's fan may stop, and steam may be seen rising from the unit. This is due to the Automatic Defrosting operation. 	9
	Air flow is stopped:	<ul style="list-style-type: none"> ● When Heating operation is started, fan speed is temporarily very low, to allow internal parts to warm up. ● During Heating operation, if the room temperature rises above the thermostat setting, the outdoor unit will stop, and the indoor unit will operate at very low fan speed. If you wish to warm the room further, set the thermostat to a higher setting. 	—
		<ul style="list-style-type: none"> ● During Heating operation, the unit will temporarily stop operation (between 2 and 16 minutes) as the Automatic Defrosting mode operates. During the Automatic Defrosting operation,  will be shown on the remote controller display. 	9
		<ul style="list-style-type: none"> ● The fan may operate at very low speed when the unit is monitoring the room's temperature. 	—
		<ul style="list-style-type: none"> ● In the monitor AUTO operation, the fan will operate at very low speed. 	—
<ul style="list-style-type: none"> ● In case of Multi-type unit, if multiple units are operated in different operation modes as shown below, the units operated afterward will stop and  will be shown on the remote controller display of the stopped indoor units. Heating mode and cooling mode (or dry mode) Heating mode and fan mode 		10	
Water is produced from the outdoor unit:	<ul style="list-style-type: none"> ● During Heating operation, water may be produced from the outdoor unit due to the Automatic Defrosting operation. 	9	
 thermo sensor display on the remote controller is flashing:	<ul style="list-style-type: none"> ● The room temperature sensor may be malfunctioning. Please consult authorized service personnel. 	—	

TROUBLESHOOTING

	Symptom	Items to check	See page
CHECK ONCE MORE	Doesn't operate at all:	<ul style="list-style-type: none"> ● Has there been a power failure? ● Has a fuse blown out, or a circuit breaker been tripped? 	—
		<ul style="list-style-type: none"> ● Is the timer operating? 	5 to 7
	Poor Cooling (or Heating) performance:	<ul style="list-style-type: none"> ● Is the air filter dirty? ● Are the air conditioner's intake grille or outlet port blocked? ● Did you adjust the room temperature settings (thermostat) correctly? ● Is there a window or door open? ● In the case of Cooling operation, is a window allowing bright sunlight to enter? (Close the curtains.) ● In the case of Cooling operation, are there heating apparatus and computers inside the room, or are there too many people in the room? 	—

If the problem persists after performing these checks, or if you notice burning smells, stop operation immediately, turn off the electrical breaker, and consult with authorized service personnel.

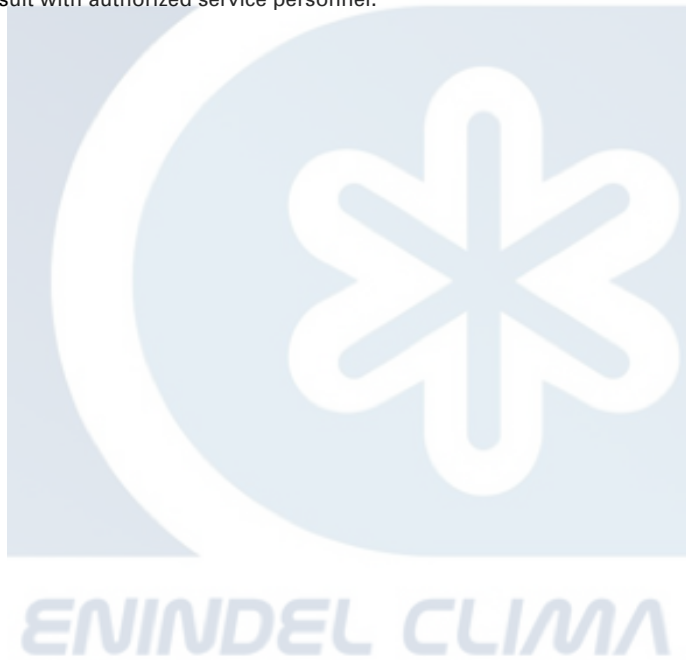



ENINDEL CLIMA